

SOFT WINDOW FASHIONS



PRODUCT & SPEC GUIDE

ROMAN SHADES & SOFT DESIGNS

INDEX

Roman Shades	4
Draperies Panels	36
Pole Mounted Valances	64
Board Mounted Valances	73
Upholstered Cornice Boards	80
Decorative Hardware	84
Trim	85



ROMAN SHADES

Roman Shades offer the fashion of soft drapery while providing privacy and light control.

ring top drapery panels: neptune/poly brocade, brick
with plain classic pleated roman shades: ashton stripe/poly awning stripe, camel

ROMAN SHADE STYLES

- > Pictured are standard ROMAN SHADES with cord locks on back, no valances
- > Valances are included on shades with these lift options only: CCO (outside mount only)
Cords Forward and Top Down Bottom Up
- > See page 21 for the lift systems

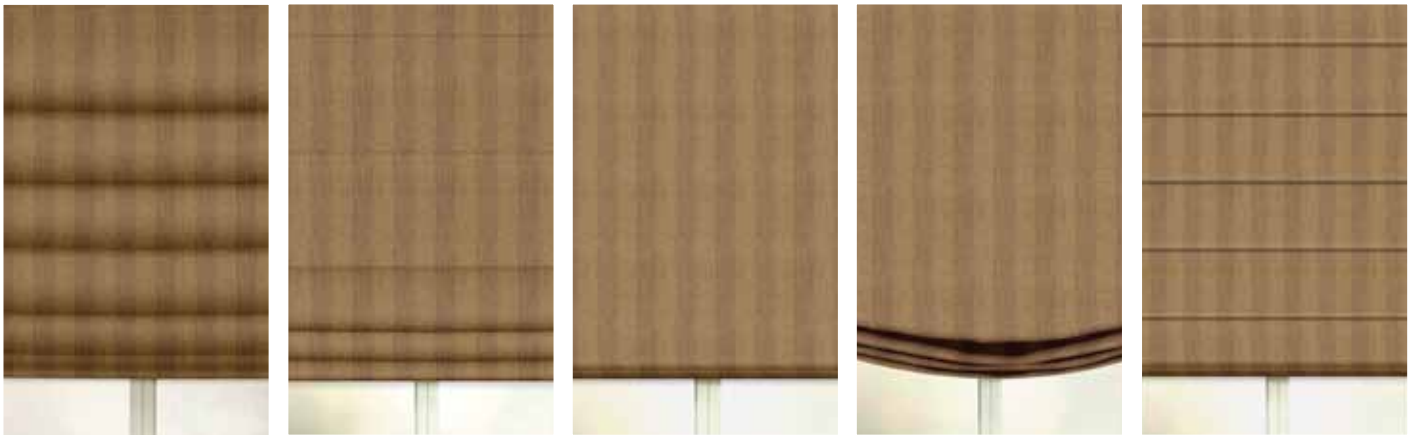

Soft Fold/Hobbled Plain Classic Pleated Flat Fold European/Relaxed Front Slat

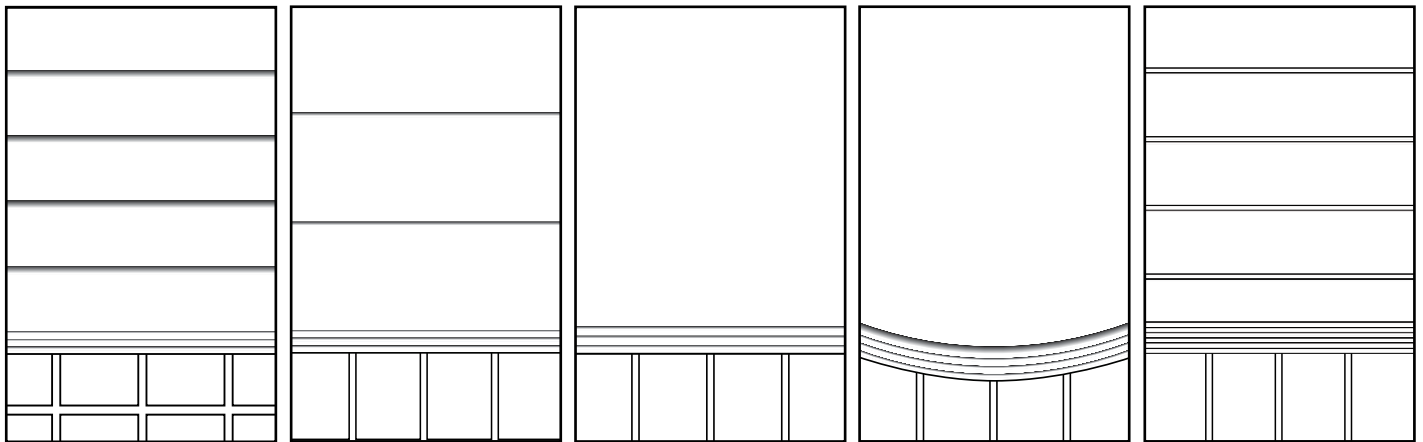

	minimum	maximum
width	12"W	120"W
length	16"L	120"L

	minimum	maximum
width	12"W	120"W
length	16"L	120"L

	minimum	maximum
width	12"W	120"W
length	16"L	120"L

	minimum	maximum
width	30"W	120"W
length	16"L	120"L

	minimum	maximum
width	12"W	48"W
length	16"L	120"L

* outside mount only

Phase II Roman Shades are in compliance with ANSI/WCMA A100.1-20102: American National Standard for Safety of Corded Window Covering Products

Face fabric hobbled onto the lining at regular 6" intervals creates cascading soft folds.

- > When using a pattern with a large repeat, the pattern will be interrupted at each pleat/fold.
- > 2" banded trim option available (along the edges or inset 2" from edges), see page 16-17
- > For 6 different lining options, see page 20
- > For lift options, see page 21

- > **When ordering for multiple windows in one room, choose and order the longest length to assure uniformity amongst all windows.**

minimum & maximum widths & lengths		
	minimum	maximum
width	12"W	120"W
length	16"L	120"L

> For additional spec info, see p.22-23/Pleat Break Point Chart, p.24



soft fold/hobbled roman shade:
 lucky/cotton sateen, silver
 inner grommet panels: lucky/cotton sateen, silver
 outer grommet panels: camelot/silkesse, oxford



soft fold/hobbled roman shade:
 neptune/poly brocade, sage

SOFT FOLD/HOBBLED



soft fold/hobbled roman shade: uma/raffia texture, wheat
standard cord locks on back with standard lining

PLAIN CLASSIC PLEATED



plain classic pleated top down bottom up roman shades:
captiva/sandrift texture, bone

A structured,
contemporary look
which requires
minimal dressing.

- > Stay pockets on the back of the shade create pleats which stacks very efficiently and look great with most fabrics.
- > All fabrics look good with this style, but it should be noted that stay pockets do interrupt the prints.
- > 2" banded trim option available (along the edges or inset 2" from edges), see page 16-17
- > For 6 different lining options, see page 20
- > For lift options, see page 21

minimum & maximum widths & lengths		
	minimum	maximum
width	12"W	120"W
length	16"L	120"L

> For additional spec info, see p.22-23/Pleat Break Point Chart, p.25



plain classic pleated roman shade:
ashton stripe/poly awning stripe, navy



plain classic pleated roman shade:
ashton stripe/poly awning stripe, camel

FLAT FOLD



flat fold roman shade: camelot/silkesse, walnut
standard cord locks on back with standard lining

A simple, elegant, tailored design with no horizontal seams.

- > This tailored style is an excellent choice for fabrics with large scale patterns that look best without interruption. When fully extended the entire pattern is displayed.
- > Small tack stitches used to attach the cord rings are visible on the face of the shade.
- > Plastic stays can be visible when backlit, but can be removed after "pleat memory" sets in.



example of plastic stays when backlit

- > When first installed this style should be pulled up fully and left in place several days to create "pleat memory".
- > 2" banded trim option available (along the edges or inset 2" from edges), see page 16-17
- > For 6 different lining options, see page 20
- > For lift options, see page 21

minimum & maximum widths & lengths		
	minimum	maximum
width	12"W	120"W
length	16"L	120"L

- > For additional spec info, see p.22-23/Pleat Break Point Chart, p.26

flat fold roman shade: genova/ogee embroidery, mineral

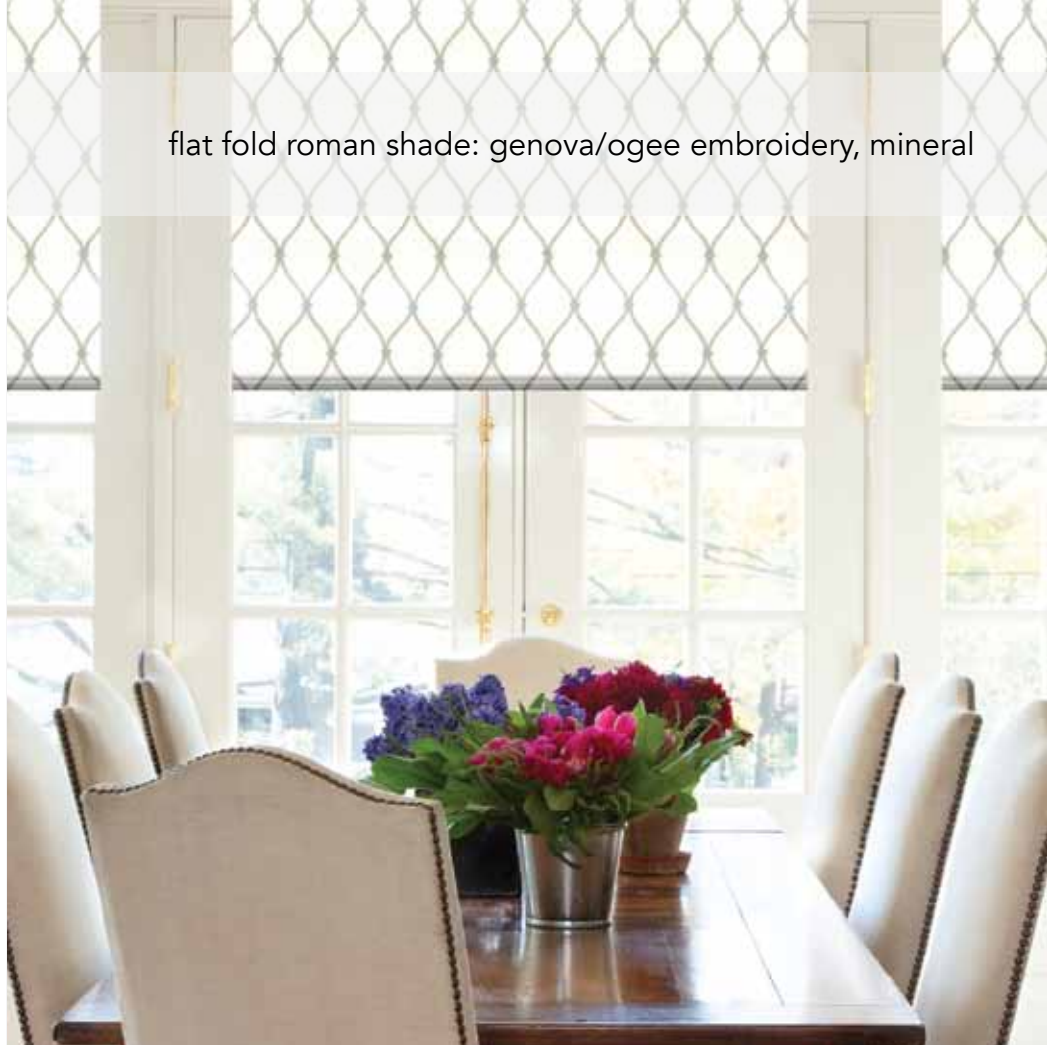

flat fold roman shade: lyon/floating vine, golden

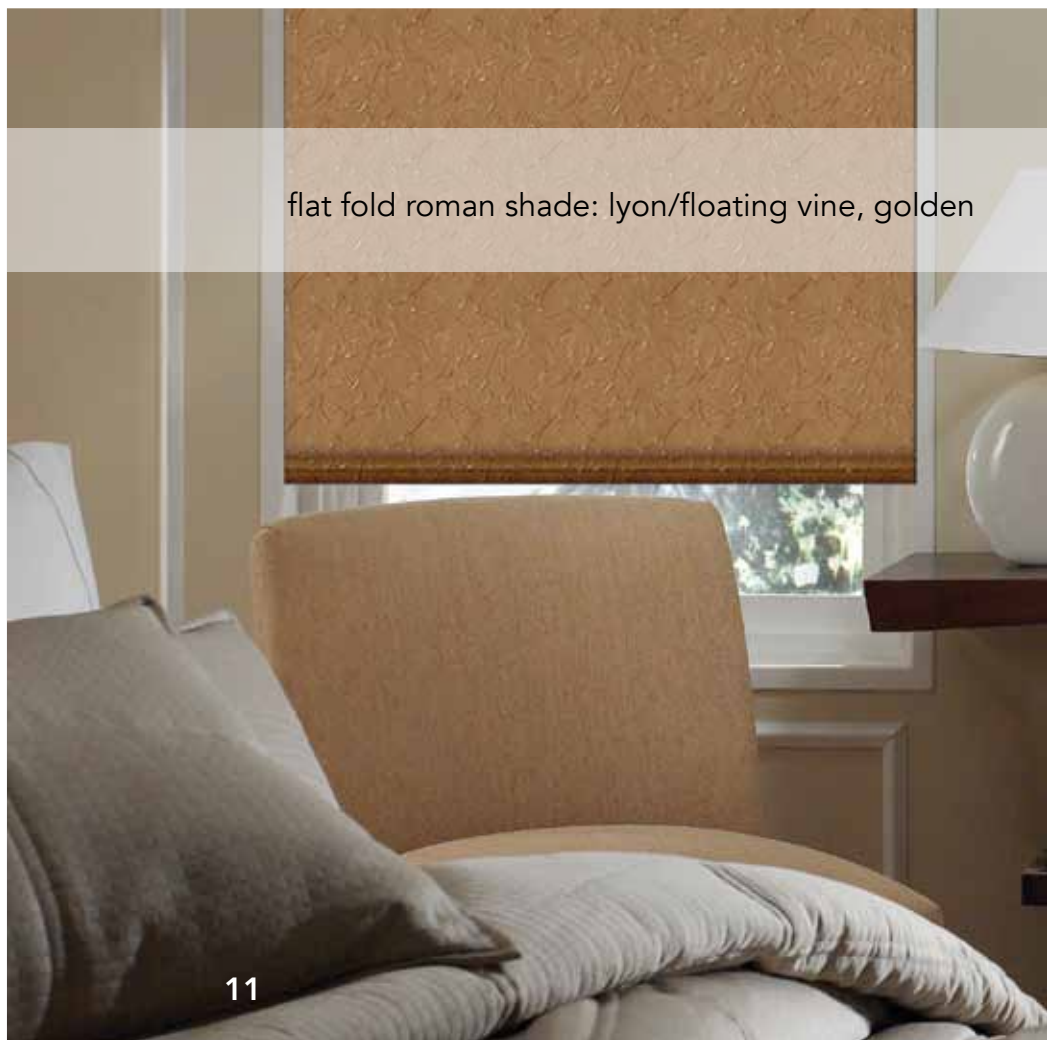

As the sides curve upward when raised, the european/relaxed shade gathers in soft folds.

minimum & maximum widths & lengths		
	minimum	maximum
width	30"W	120"W
length	16"L	120"L

One scoop under 60" W
Two scoops over 60" W



euro relaxed board mounted valance

- > Small tack stitches used to attach the cord rings are visible on the face of the shade. When first installed this style should be pulled up fully and left in place several days to create "pleat memory".
- > Outside mount only
- > No decorative trim upgrades available
- > For 6 different lining options, see page 20
- > For lift options, see page 21
- > **Be advised: This shade takes manual adjusting to achieve the desired effect. It is not recommended for frequent use, but more as a decorative shade.**
- > See **Euro Relaxed Board Mounted Valance** on page 69 for a stationary, low maintenance option.
- > For additional spec info, see p.22-23/Pleat Break Point Chart, p.27

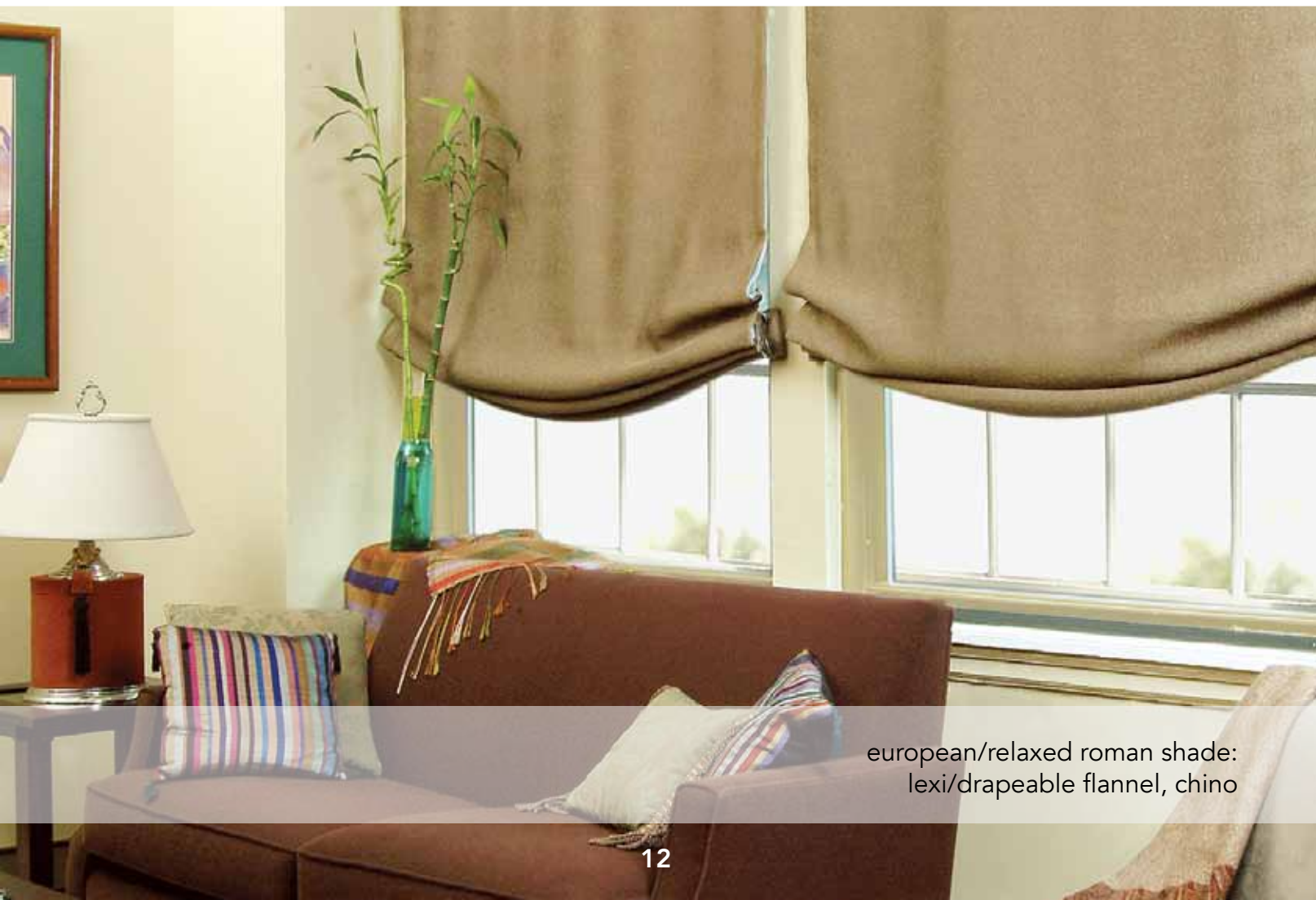

european/relaxed roman shade:
lexi/drapeable flannel, chino

EUROPEAN/RELAXED



european/relaxed roman shade: camelot/silkesse, tussah
standard cord locks on back with standard lining

FRONT SLATS



front slats roman shade: lexi/drapeable flannel, chino
standard cord locks on back with standard lining
soft wave fold & track system (front track): ikat ombre horizontal stripe, coconut
soft wave fold & track system (back track): raw silk crepe/linen sheer look, pebble

Add some drama to a plain fabric with this structured, contemporary look.

- > The face of the shade has slats sewn into pockets that give the shade a precise look. This is a structured, contemporary look that requires minimal dressing.
- > No decorative trim upgrades available
- > For 6 different lining options, see page 20
- > For lift options, see page 21

> **Note: 95% Room Darkening Blackout is not available for this shade style**

minimum & maximum widths & lengths		
	minimum	maximum
width	12"W	48"W
length	16"L	120"L

NO WIDTHS OVER 48"W (due to the nature of the shade construction)

- > For additional spec info, see p.22-23/Pleat Break Point Chart, p.28



front slats roman shade (center): imari/flower power print, indigo
front slats roman shade (sides): kitani/y print, indigo



front slats roman shade: wilmington/cotton duck, natural

2" banding colors



white



ivory



grey



taupe



gold



burgundy



navy



black



plain classic pleated roman shade: wilmington/cotton duck, white with black inset ribbon banding with premium blackout lining

Add a custom designer finish by adding an edge or inset BANDED trim.

- > 100% rayon ribbon
- > 2" wide
- > 8 colors available
- > styles:
 - flat fold
 - plain classic pleated
 - soft fold/hobbled
- > lift:
 - cord lock
 - continuous cord loop (CCO)
 - cordless
- > inset = 2" in from edge (left, right, bottom)
- > edge = along the edges (left, right, bottom)
- > valances automatically get matching edge or inset banding too, for same surcharge
- > valances are included on:
 - cord lock: cords forward, top down bottom up
 - continuous chain: outside mount

BANDED OPTION for Roman Shades



**plain classic pleated roman shade:
lucky/cotton sateen, white with grey ribbon edge banding
with premium privacy lining**

CORDLESS LIFT OPTION



plain classic pleated cordless roman shade: camelot/silkesse, pomegranate
with premium privacy lining

The most reliable and affordable **CORDLESS LIFT OPTION** in hand-crafted fashion Roman Shades.

minimum & maximum widths & lengths		
	minimum	maximum
width	18"W	84"W
length	18"L	84"L

> The #1 LIFT OPTION in blinds & shades

> 30 Fabrics Options:

- * Amagansett/Mod Floral
- * Ashton Stripe/Poly Awning Stripe
- * Bermuda/Plisse Scroll
- * Camelot/Silkesse
- * Captiva/Sandrift Texture
- * Charleston/Bandana Floral
- * Donetta/Ironwork Print
- * Farrell Print/Country Blossom
- * Genova/Ogee Embroidery
- * Harrison Stripe/Relaxed Stripe
- * Imari/Flower Power Print
- * Kitani/Y Print
- * Lexi/Drapeable Flannel
- * Lyon/Floating Vine
- * Lucky/Cotton Sateen
- * Madison/Cotton Candlewicking
- * Meta/Cabana Stripe
- * Moorea/Flock Leaf
- * Orlando/Braid Jacquard
- * Polaris/Asymmetrical Tonal Stripe
- * Raw Silk Crepe/Linen Sheer Look
- * Regal Square/Square Dot
- * Rio/Faux Linen
- * Silkara/Shimmery Crosshatch Texture
- * Silk Road/Reeded Silk Stripe
- * Species/Animal Jacquard
- * Sri Lanka/Tribal Print
- * St. Moritz/Stainglass Floral
- * Tullahoma/Ikat Print
- * Wilmington/Cotton Duck

> 2 best linings available:

- * Standard Light Filtering
- * 100% Premium Blackout

> 2 best roman styles:

- * Soft Fold/Hobbled
- * Plain Classic Pleated

> Clean, stream-lined and contemporary

> The very BEST PRICE!

> Child and Pet Safe

> **For additional spec info, see p.22-23/
Pleat Break Point Chart, p.29**



plain classic pleated cordless roman shade:
ashton stripe/poly awning stripe, camel
ring top panels: neptune/poly brocade, brick

Lining Options

Standard Lining

- > Basic light weight lining:
70% polyester/30% cotton
- > Protects fabric from the sun
- > Provides neutral color to outside
- > 54"



ivory



white

Thermal Sateen Lining

- > Medium weight 100% polyester
- > Smooth sheen finish
- > Provides protection from heat & cold and protects from UV rays which could lead to fading
- > 54"
- > 1 pass acrylic latex foam backing
- > Light filtering



ivory

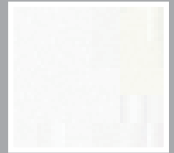

white

Room Darkening Lining

- > Luxurious triple cloth 100% polyester
- > Woven-in black layer gives slight grey appearance to white on outside
- > Excellent drapability
- > Room darkening lining does let some light in: blocks out 95% sunlight
- > Pinhole resistant due to woven construction
- > 54"
- > Light filtering

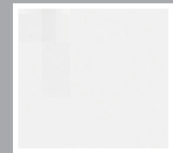

white

Premium Blackout Lining

- > Heavy weight lining: 100% polyester
- > Blocks out 100% sunlight
- > Use for blackout on less opaque, light colored fabric
- > 54"
- > 3 pass acrylic latex foam backing
- > Although we take every precaution to avoid piercing this lining, on the Plain shade style, light seepage may still occur through perforations

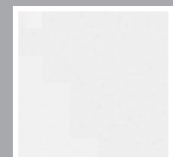

white

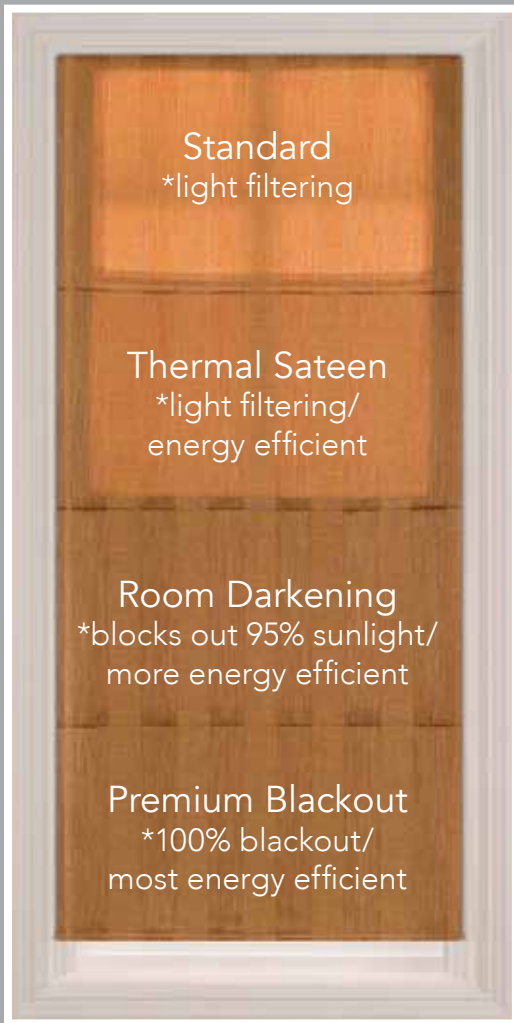

Standard
*light filtering

Thermal Sateen
*light filtering/
energy efficient

Room Darkening
*blocks out 95% sunlight/
more energy efficient

Premium Blackout
*100% blackout/
most energy efficient

Roman Shade Lift System Upgrade Options



Cords Forward

- Includes valance
 - Outside mount valance has returns
 - Inside mount valance - no returns
- 1/4" deduction taken by factory on inside mount
- Color coordinated cords used
- Maximum: 120"W, 120"L



CCO inside mount

- No valance
- 1/4" deduction taken by factory
- 2" head board used
- Minimum: 24"L
- Maximum: 120"W, 120"L



CCO outside mount

- Includes valance with returns
- Shade will be exact measurement provided
- Head rail will be +1" wider than the shade for outside mount only
- 2" head board used
- Minimum: 24"L
- Maximum: 120"W, 120"L



Cordless

- No valance at all
- Outside mount has 6" long side returns
- 1/4" deduction taken by factory on inside mount
- Minimum: 18"W x 18"L
- Maximum: 84"W x 84"L
- Soft fold & plain only
- Select fabrics & linings only

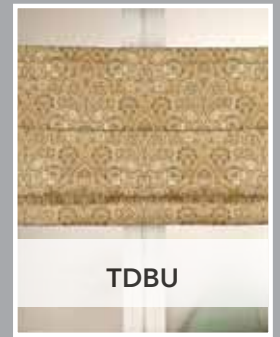

TDBU

- Includes valance
 - Outside mount valance has returns
 - Inside mount valance has no returns
- 1/4" deduction taken by factory on inside mount
- Head rail will be 1" wider than shade for outside mount only
- White cords used because it is unattractive to have colored cords in view when the top comes down
- Maximum: 120" W, 120"L
- NOTE: Shade length adjustable 1-2" by raising or lowering the top head rail.



2 on 1 Head Rail

- Available standard cord lock (cords back/no valance, cords forward/includes valance)
- Available CCO (inside mount/ no valance, outside mount/ includes valance)
- Minimum: 48"W (two 24"W)

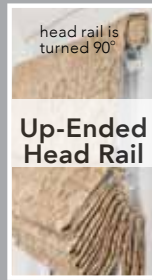

head rail is turned 90°
Up-Ended Head Rail

- Head rail is turned 90° to fit slim windows & doors
- For narrow depth windows/ French Doors - 3/4" depth needed for inside mount
- Not available in CCO, TDBU or Cordless

Combined Options					
	Continuous Cord Loop	Cords Forward	Cordless	Up-Ended	2 on 1 Head Rail
Continuous Cord Loop (CCO)	see photo	N/A	N/A	N/A	by request
Cords Forward (CF)	N/A	see photo	N/A	yes	yes
Cordless	N/A	N/A	see photo	N/A	N/A
Up-Ended	N/A	yes	N/A	turned 90°	yes
2 on 1 Head Rail	by request	yes	N/A	yes	see photo

Roman Shade Info

OUTSIDE mount widths come exactly as measurement provided, with L brackets for mounting outside window frame
 INSIDE mount widths come with -1/4" factory deduction off measurement provided and pre-drilled holes

Minimum/Maximum Sizes				
Style	Minimum		Maximum	
	Width	Length	Width	Length
Flat Fold	12"	16"	120"	120"
European/Relaxed	30"	16"	120"	120"
Plain Classic Pleated	12"	16"	120"	120"
Soft Fold/Hobbled	12"	16"	120"	120"
Front Slats	12"	16"	48"	120"
Cordless	18"	18"	84"	84"

**Cordless in Classic Pleated and Soft Fold ONLY

Depth Required for Inside Mount		
Lift System	Flush Mount	Regular Mount
Standard Cord Lock	1 1/2"	1 1/4"
Cords Forward	1 1/2"	1 1/4"
Top-Down Bottom Up	2 1/4"	2"
CCO/Chain Drive (68"x68" and under)	2 1/4"	2"
CCO/Chain Drive (over 68"x68")	3 1/4"	2"
Cordless	2"	1 1/2"
Up-Ended	3 1/4"	1 1/2"

Continuous Cord Loop Lengths		
Shade Length	Chain Loop Drop Length (feet)	Chain Loop Drop Length (inches)
Up to 36" L	2'	24"
36 1/8" L - 54" L	3'	36"
54 1/8" L - 72" L	4'	48"
72 1/8" L - 90" L	5'	60"
90 1/8" L - 120" L	6'	72"

Dimensions		
Lift System Options	Head Rail Sizes	Outside Mount Brackets
Standard Cord Lock	3/4" H x 1 1/4" D	1" x 1" L - bracket
Up-Ended	1 1/4" H x 3/4" D	1" x 1" L - bracket
Cords Forward	3/4" H x 1 1/4" D	1" x 1" L - bracket
Top-Down/Bottom-Up	3/4" H x 2" D	1 1/2" x 1 1/2" L - bracket
CCO/Chain Drive (68"x68" and under)	3/4" H x 2 1/4" D	1 1/2" x 1 1/2" L - bracket
CCO/Chain Drive (over 68"x68")	3/4" H x 3 1/4" D	1 1/2" x 1 1/2" L - bracket

**Inside mount shades are supplied with pre-drilled holes in headrails without installation hardware.

Valances are included on shades with these lift options only: CCO (outside mount only), CF, TDBU

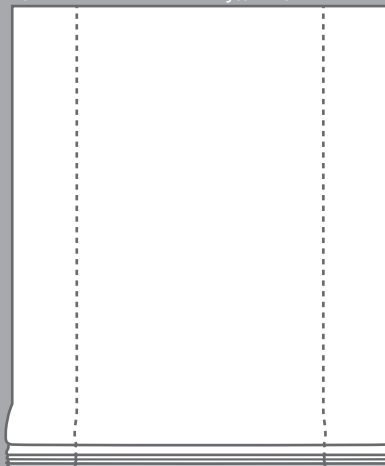

Seamed Roman Shades

- Seamless Roman Shades are available up to a maximum of 48" wide. Beyond 48" wide, shades will be made with a varying width center panel and side panels seamed to a minimum of 9" wide on both sides.

Stack Heights for Roman Shades

for CCO & Standard Cord Locks		for CORDLESS shades					
		Stack Heights					
Stack Heights		Plain Classic Pleated CORDLESS		Soft Fold CORDLESS		Soft Fold CORDLESS, cont'd	
Flat Fold, Soft Fold, European/Relaxed		Shade Length	Stack Length	Shade Length	Stack Length	Shade Length	Stack Length
24"	7" - 8"	12-13"	7-8"	18 -19 ¹ / ₄ "	10-11"	51 ³ / ₈ -52 ¹ / ₈ "	13-14"
36"	7" - 8"	13-14"	8-9"	19 ³ / ₈ -20 ¹ / ₄ "	11-12"	52 ¹ / ₄ -53 ³ / ₈ "	8-9"
42"	7" - 8"	14 ¹ / ₂ -20 ¹ / ₄ "	8 ¹ / ₄ "	20 ³ / ₈ -21 ¹ / ₄ "	12-13"	53 ³ / ₈ -54 ¹ / ₄ "	9-10"
48"	7" - 8"	20 ¹ / ₂ -22 ¹ / ₄ "	10 ¹ / ₄ "	21 ³ / ₈ -22 ¹ / ₈ "	13-14"	54 ³ / ₈ -55 ¹ / ₄ "	10-11"
54"	7" - 8"	22 ¹ / ₂ -28 ¹ / ₄ "	8 ¹ / ₄ "	22 ¹ / ₄ -23 ¹ / ₄ "	8-9"	55 ³ / ₈ -56 ¹ / ₄ "	11-12"
60"	7" - 8"	28 ¹ / ₂ -36 ¹ / ₄ "	9 ¹ / ₄ "	23 ³ / ₈ -24 ¹ / ₄ "	9-10"	56 ³ / ₈ -57 ¹ / ₄ "	12-13"
62"	7" - 8"	36 ¹ / ₂ -44 ¹ / ₄ "	9 ¹ / ₄ "	24 ³ / ₈ -25 ¹ / ₄ "	10-11"	57 ³ / ₈ -58 ¹ / ₈ "	13-14"
66"	7" - 8"	44 ¹ / ₂ -52 ¹ / ₄ "	10 ¹ / ₄ "	25 ³ / ₈ -26 ¹ / ₄ "	11-12"	58 ¹ / ₄ -59 ¹ / ₄ "	8-9"
72"	7" - 8"	52 ¹ / ₂ -60 ¹ / ₄ "	10 ³ / ₄ "	26 ³ / ₈ -27 ¹ / ₄ "	12-13"	59 ³ / ₈ -60 ¹ / ₄ "	9-10"
84"	7 ¹ / ₂ " - 8 ¹ / ₂ "	60 ¹ / ₂ -68"	11 ¹ / ₄ "	27 ³ / ₈ -28 ¹ / ₈ "	13-14"	60 ³ / ₈ -61 ¹ / ₄ "	10-11"
96"	8" - 9"	68 ³ / ₈ -76"	11 ³ / ₄ "	28 ¹ / ₄ -29 ¹ / ₄ "	8-9"	61 ³ / ₈ -62 ¹ / ₄ "	11-12"
		76 ¹ / ₈ -84"	12 ¹ / ₄ "	29 ³ / ₈ -30 ¹ / ₄ "	9-10"	62 ³ / ₈ -63 ¹ / ₄ "	12-13"
				30 ³ / ₈ -31 ¹ / ₄ "	10-11"	63 ³ / ₈ -64 ¹ / ₈ "	13-14"
				31 ³ / ₈ -32 ¹ / ₄ "	11-12"	64 ¹ / ₄ -65 ¹ / ₄ "	8-9"
				32 ³ / ₈ -33 ¹ / ₄ "	12-13"	65 ³ / ₈ -66 ¹ / ₄ "	9-10"
				33 ³ / ₈ -34 ¹ / ₈ "	13-14"	66 ³ / ₈ -67 ¹ / ₄ "	10-11"
				34 ¹ / ₄ -35 ¹ / ₄ "	8-9"	67 ³ / ₈ -68 ¹ / ₄ "	11-12"
				35 ³ / ₈ -36 ¹ / ₄ "	9-10"	68 ³ / ₈ -69 ¹ / ₄ "	12-13"
				36 ³ / ₈ -37 ¹ / ₄ "	10-11"	69 ³ / ₈ -70 ¹ / ₈ "	13-14"
				37 ¹ / ₄ -38 ¹ / ₄ "	11-12"	70 ¹ / ₄ -71 ¹ / ₄ "	8-9"
				38 ³ / ₈ -39 ¹ / ₄ "	12-13"	71 ¹ / ₈ -72 ¹ / ₄ "	9-10"
				39 ³ / ₈ -40 ¹ / ₈ "	13-14"	72 ³ / ₈ -73 ¹ / ₄ "	10-11"
				40 ¹ / ₄ -41 ¹ / ₄ "	8-9"	73 ³ / ₈ -74 ¹ / ₄ "	11-12"
				41 ³ / ₈ -42 ¹ / ₄ "	9-10"	74 ³ / ₈ -75 ¹ / ₄ "	12-13"
				42 ³ / ₈ -43 ¹ / ₄ "	10-11"	75 ³ / ₈ -76 ¹ / ₈ "	13-14"
				43 ³ / ₈ -44 ¹ / ₄ "	11-12"	76 ¹ / ₄ -77 ¹ / ₄ "	8-9"
				44 ³ / ₈ -45 ¹ / ₄ "	12-13"	77 ³ / ₈ -78 ¹ / ₄ "	9-10"
				45 ³ / ₈ -46 ¹ / ₈ "	13-14"	78 ³ / ₈ -79 ¹ / ₄ "	10-11"
				46 ¹ / ₄ -47 ¹ / ₄ "	8-9"	79 ³ / ₈ -80 ¹ / ₄ "	11-12"
				47 ³ / ₈ -48 ¹ / ₄ "	9-10"	80 ³ / ₈ -81 ¹ / ₄ "	12-13"
				48 ³ / ₈ -49 ¹ / ₄ "	10-11"	81 ³ / ₈ -82 ¹ / ₈ "	13-14"
				49 ³ / ₈ -50 ¹ / ₄ "	11-12"	82 ¹ / ₄ -83 ¹ / ₄ "	8-9"
				50 ³ / ₈ -51 ¹ / ₄ "	12-13"	83 ³ / ₈ -84"	9-10"

Pleat Break Points for SOFT FOLD Roman Shades

only for Standard Cord Locks & CCO

Soft Fold Roman Shades						
	Length Range		Number of 5 ³ / ₈ " Pleats	Varying Bottom Pleat Size Range		Total # of Pleats
	minimum	maximum		minimum	maximum	
Range 1	18"	22 ⁷ / ₈ "	3	1 ¹ / ₂ "	6 ³ / ₄ "	4
Range 2	23"	28 ¹ / ₄ "	4	1 ¹ / ₂ "	6 ³ / ₄ "	5
Range 3	28 ³ / ₈ "	33 ⁵ / ₈ "	5	1 ¹ / ₂ "	6 ³ / ₄ "	6
Range 4	33 ³ / ₄ "	39"	6	1 ¹ / ₂ "	6 ³ / ₄ "	7
Range 5	39 ¹ / ₈ "	44 ³ / ₈ "	7	1 ¹ / ₂ "	6 ³ / ₄ "	8
Range 6	44 ¹ / ₂ "	49 ³ / ₄ "	8	1 ¹ / ₂ "	6 ³ / ₄ "	9
Range 7	49 ⁷ / ₈ "	55 ¹ / ₈ "	9	1 ¹ / ₂ "	6 ³ / ₄ "	10
Range 8	55 ¹ / ₄ "	60 ¹ / ₂ "	10	1 ¹ / ₂ "	6 ³ / ₄ "	11
Range 9	60 ⁵ / ₈ "	65 ⁷ / ₈ "	11	1 ¹ / ₂ "	6 ³ / ₄ "	12
Range 10	66"	71 ¹ / ₄ "	12	1 ¹ / ₂ "	6 ³ / ₄ "	13
Range 11	71 ³ / ₈ "	76 ⁵ / ₈ "	13	1 ¹ / ₂ "	6 ³ / ₄ "	14
Range 12	76 ³ / ₄ "	82"	14	1 ¹ / ₂ "	6 ³ / ₄ "	15
Range 13	82 ¹ / ₂ "	87 ³ / ₈ "	15	1 ¹ / ₂ "	6 ³ / ₄ "	16
Range 14	87 ¹ / ₂ "	93 ³ / ₄ "	16	1 ¹ / ₂ "	6 ³ / ₄ "	17
Range 15	92 ⁷ / ₈ "	98 ¹ / ₈ "	17	1 ¹ / ₂ "	6 ³ / ₄ "	18
Range 16	98 ¹ / ₄ "	103 ¹ / ₂ "	18	1 ¹ / ₂ "	6 ³ / ₄ "	19
Range 17	103 ⁵ / ₈ "	108 ⁷ / ₈ "	19	1 ¹ / ₂ "	6 ³ / ₄ "	20
Range 18	109"	114 ¹ / ₄ "	20	1 ¹ / ₂ "	6 ³ / ₄ "	21
Range 19	114 ³ / ₈ "	119 ⁵ / ₈ "	21	1 ¹ / ₂ "	6 ³ / ₄ "	22
Range 20	119 ³ / ₄ "	120"	22	1 ¹ / ₂ "	6 ³ / ₄ "	23

Pleat Break Diagrams

- Built from top - down
- Useful for different size windows which are next to each other
- **The bottom pleat will vary from 1¹/₂" to 6³/₄"**

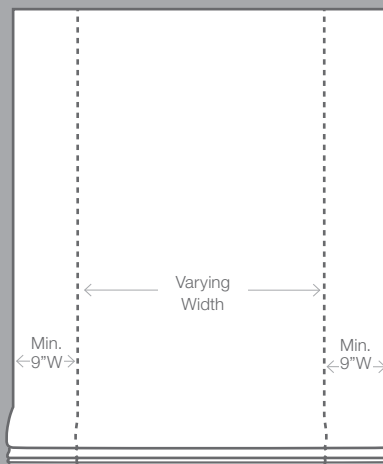
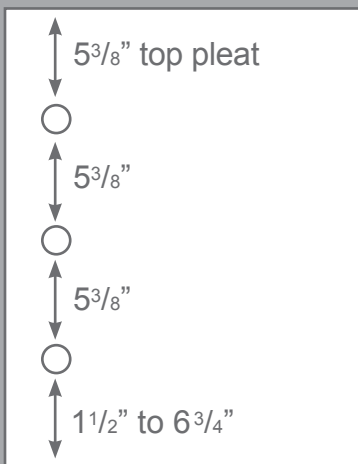
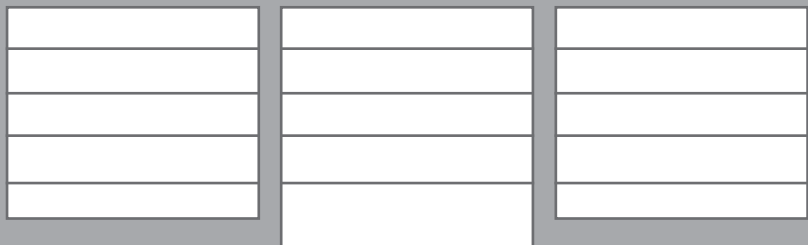

Seamed Roman Shades

- Seamless Roman Shades are available up to a maximum of 48" wide. Beyond 48" wide, shades will be made with a varying width center panel and side panels seamed to a minimum of 9" wide on both sides.

Pleat Break Points for SOFT FOLD Roman Shades with RIBBON BANDING (on the edge & inset)

only for Standard Cord Locks & CCO

Soft Fold Roman Shades with Ribbon Banding								
	Length Range		Number of 5 ³ / ₈ " Pleats	Varying Bottom Pleat Size Range		Varying Top Pleat Size Range		Total # of Pleats
	minimum	maximum		minimum	maximum	minimum	maximum	
Range 1	18"	18 7/8"	1	5 3/4"	6 3/4"	2 1/2"	7 3/4"	3
Range 2	19"	24 1/4"	2	5 3/4"	6 3/4"	2 1/2"	7 3/4"	4
Range 3	24 3/8"	29 5/8"	3	5 3/4"	6 3/4"	2 1/2"	7 3/4"	5
Range 4	29 3/4"	35"	4	5 3/4"	6 3/4"	2 1/2"	7 3/4"	6
Range 5	35 1/8"	40 3/8"	5	5 3/4"	6 3/4"	2 1/2"	7 3/4"	7
Range 6	40 1/2"	45 3/4"	6	5 3/4"	6 3/4"	2 1/2"	7 3/4"	8
Range 7	45 7/8"	51 1/8"	7	5 3/4"	6 3/4"	2 1/2"	7 3/4"	9
Range 8	51 1/4"	56 1/2"	8	5 3/4"	6 3/4"	2 1/2"	7 3/4"	10
Range 9	56 5/8"	61 7/8"	9	5 3/4"	6 3/4"	2 1/2"	7 3/4"	11
Range 10	62"	67 1/4"	10	5 3/4"	6 3/4"	2 1/2"	7 3/4"	12
Range 11	67 3/8"	72 5/8"	11	5 3/4"	6 3/4"	2 1/2"	7 3/4"	13
Range 12	72 3/4"	78"	12	5 3/4"	6 3/4"	2 1/2"	7 3/4"	14
Range 13	78 1/8"	83 3/8"	13	5 3/4"	6 3/4"	2 1/2"	7 3/4"	15
Range 14	83 1/2"	88 3/4"	14	5 3/4"	6 3/4"	2 1/2"	7 3/4"	16
Range 15	88 7/8"	94 1/8"	15	5 3/4"	6 3/4"	2 1/2"	7 3/4"	17
Range 16	94 1/4"	99 1/2"	16	5 3/4"	6 3/4"	2 1/2"	7 3/4"	18
Range 17	99 5/8"	104 7/8"	17	5 3/4"	6 3/4"	2 1/2"	7 3/4"	19
Range 18	105"	110 1/4"	18	5 3/4"	6 3/4"	2 1/2"	7 3/4"	20
Range 19	110 3/8"	115 5/8"	19	5 3/4"	6 3/4"	2 1/2"	7 3/4"	21
Range 20	115 3/4"	120"	20	5 3/4"	6 3/4"	2 1/2"	7 3/4"	22

Pleat Break Diagrams

- Built from bottom - up
- The top pleat will vary from 2 1/2" to 7 3/4"
- The bottom pleat will vary from 5 3/4" to 6 3/4"

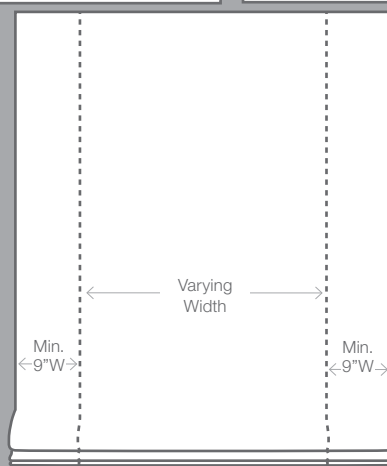
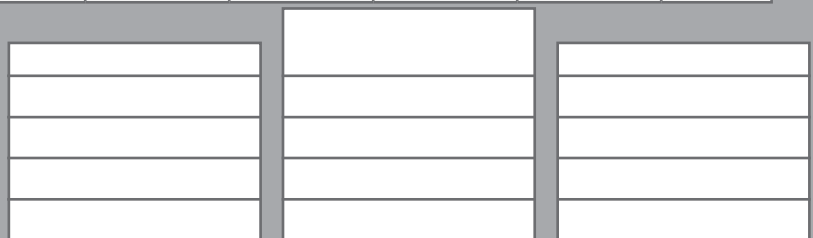
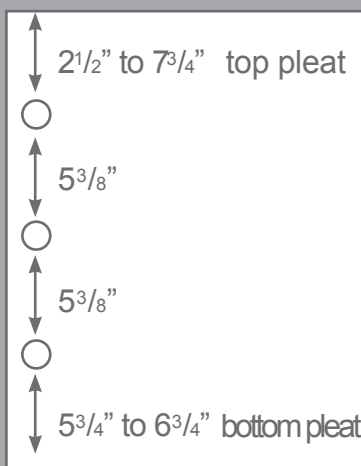

Seamed Roman Shades

- Seamless Roman Shades are available up to a maximum of 48" wide. Beyond 48" wide, shades will be made with a varying width center panel and side panels seamed to a minimum of 9" wide on both sides.

Pleat Break Points for SOFT FOLD CORDLESS Roman Shades WITH RIBBON BANDING (on the edge & inset) and WITHOUT

for CORDLESS

Soft Fold CORDLESS Roman Shades						
	Length Range		Number of 5 1/4" - 6" Pleats	Varying Bottom Pleat Size Range		Total # of Pleats
	minimum	maximum		minimum	maximum	
Range 1	17"	21 1/8"	2	5"	10 7/8"	3
Range 2	21 1/4"	27 1/8"	3	5"	10 7/8"	4
Range 3	27 1/4"	33 1/8"	4	5"	10 7/8"	5
Range 4	33 1/4"	39 1/8"	5	5"	10 7/8"	6
Range 5	39 1/4"	45 1/8"	6	5"	10 7/8"	7
Range 6	45 1/4"	51 1/8"	7	5"	10 7/8"	8
Range 7	51 1/4"	57 1/8"	8	5"	10 7/8"	9
Range 8	57 1/4"	63 1/8"	9	5"	10 7/8"	10
Range 9	63 1/4"	69 1/8"	10	5"	10 7/8"	11
Range 10	69 1/4"	75 1/8"	11	5"	10 7/8"	12
Range 11	75 1/4"	81 1/8"	12	5"	10 7/8"	13
Range 12	81 1/4"	84"	13	5"	10 7/8"	14

- Built from top - down

Pleat Break Points for PLAIN CLASSIC PLEATED Roman Shades

for Standard Cord Locks & CCO

Plain Classic Pleated Roman Shades						
	Length Range		Number of 6" Pleats	Varying Bottom Pleat Size Range		Total # of Pleats
	minimum	maximum		minimum	maximum	
Range 1	16"	19 7/8"	2	4"	7 7/8"	3
Range 2	20"	25 7/8"	3	2"	7 7/8"	4
Range 3	26"	31 7/8"	4	2"	7 7/8"	5
Range 4	32"	37 7/8"	5	2"	7 7/8"	6
Range 5	38"	43 7/8"	6	2"	7 7/8"	7
Range 6	44"	49 7/8"	7	2"	7 7/8"	8
Range 7	50"	55 7/8"	8	2"	7 7/8"	9
Range 8	56"	61 7/8"	9	2"	7 7/8"	10
Range 9	62"	67 7/8"	10	2"	7 7/8"	11
Range 10	68"	73 7/8"	11	2"	7 7/8"	12
Range 11	74"	79 7/8"	12	2"	7 7/8"	13
Range 12	80"	85 7/8"	13	2"	7 7/8"	14
Range 13	86"	91 7/8"	14	2"	7 7/8"	15
Range 14	92"	97 7/8"	15	2"	7 7/8"	16
Range 15	98"	103 7/8"	16	2"	7 7/8"	17
Range 16	104"	109 7/8"	17	2"	7 7/8"	18
Range 17	110"	115 7/8"	18	2"	7 7/8"	19
Range 18	116"	120"	19	2"	6"	20

Pleat Break Diagrams

- Built from top - down
- Useful for different size windows which are next to each other
- **The bottom pleat will vary from 2" to 7 7/8"**

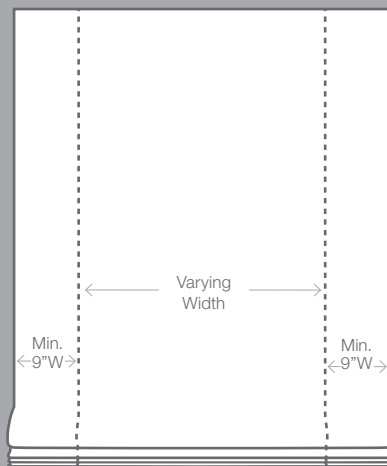
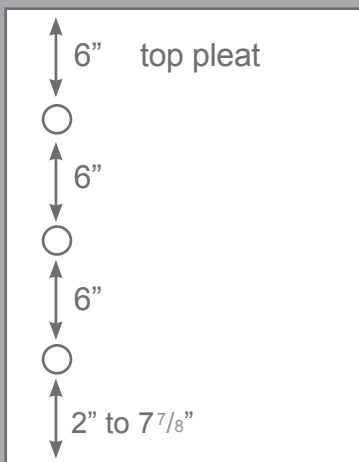
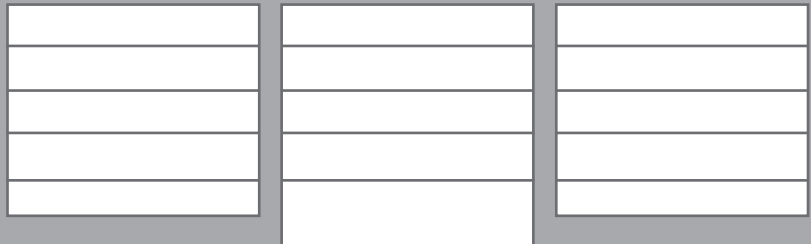

Seamed Roman Shades

- Seamless Roman Shades are available up to a maximum of 48" wide. Beyond 48" wide, shades will be made with a varying width center panel and side panels seamed to a minimum of 9" wide on both sides.

Pleat Break Points for PLAIN CLASSIC PLEATED Roman Shades with RIBBON BANDING (on the edge & inset)

for Standard Cord Locks & CCO

Plain Classic Pleated Roman Shades with Ribbon Banding							
	Length Range		Number of Pleats	Pleat Size	Varying Bottom Pleat Size Range		Total # of Pleats
	minimum	maximum			minimum	maximum	
Range 1	16 ³ / ₄ "	19 ⁷ / ₈ "	2	6	4 ³ / ₄ "	7 ⁷ / ₈ "	3
Range 2	20"	22 ⁵ / ₈ "	3	5 - 6	4 ³ / ₄ "		4
Range 3	22 ³ / ₄ "	25 ⁷ / ₈ "	3	6	4 ³ / ₄ "	7 ⁷ / ₈ "	4
Range 4	26"	28 ⁵ / ₈ "	4	5 - 6	4 ³ / ₄ "		5
Range 5	28 ³ / ₄ "	31 ⁷ / ₈ "	4	6	4 ³ / ₄ "	7 ⁷ / ₈ "	5
Range 6	32"	34 ⁵ / ₈ "	5	5 - 6	4 ³ / ₄ "		6
Range 7	34 ³ / ₄ "	37 ⁷ / ₈ "	5	6	4 ³ / ₄ "	7 ⁷ / ₈ "	6
Range 8	38"	40 ⁵ / ₈ "	6	5 - 6	4 ³ / ₄ "		7
Range 9	40 ³ / ₄ "	43 ⁷ / ₈ "	6	6	4 ³ / ₄ "	7 ⁷ / ₈ "	7
Range 10	44"	46 ⁵ / ₈ "	7	5 - 6	4 ³ / ₄ "		8
Range 11	46 ³ / ₄ "	49 ⁷ / ₈ "	7	6	4 ³ / ₄ "	7 ⁷ / ₈ "	8
Range 12	50"	52 ⁵ / ₈ "	8	5 - 6	4 ³ / ₄ "		9
Range 13	52 ³ / ₄ "	55 ⁷ / ₈ "	8	6	4 ³ / ₄ "	7 ⁷ / ₈ "	9
Range 14	56"	58 ⁵ / ₈ "	9	5 - 6	4 ³ / ₄ "		10
Range 15	58 ³ / ₄ "	61 ⁷ / ₈ "	9	6	4 ³ / ₄ "	7 ⁷ / ₈ "	10
Range 16	62"	64 ⁵ / ₈ "	10	5 - 6	4 ³ / ₄ "		11
Range 17	64 ³ / ₄ "	67 ⁷ / ₈ "	10	6	4 ³ / ₄ "	7 ⁷ / ₈ "	11
Range 18	68"	70 ⁵ / ₈ "	11	5 - 6	4 ³ / ₄ "		12
Range 19	70 ³ / ₄ "	73 ⁷ / ₈ "	11	6	4 ³ / ₄ "	7 ⁷ / ₈ "	12
Range 20	74"	76 ⁵ / ₈ "	12	5 - 6	4 ³ / ₄ "		13
Range 21	76 ³ / ₄ "	79 ⁷ / ₈ "	12	6	4 ³ / ₄ "	7 ⁷ / ₈ "	13
Range 22	80"	82 ⁵ / ₈ "	13	5 - 6	4 ³ / ₄ "		14
Range 23	82 ³ / ₄ "	85 ⁷ / ₈ "	13	6	4 ³ / ₄ "	7 ⁷ / ₈ "	14
Range 24	86"	88 ⁵ / ₈ "	14	5 - 6	4 ³ / ₄ "		15
Range 25	88 ³ / ₄ "	91 ⁷ / ₈ "	14	6	4 ³ / ₄ "	7 ⁷ / ₈ "	15
Range 26	92"	94 ⁵ / ₈ "	15	5 - 6	4 ³ / ₄ "		16
Range 27	94 ³ / ₄ "	97 ⁷ / ₈ "	15	6	4 ³ / ₄ "	7 ⁷ / ₈ "	16
Range 28	98"	100 ⁵ / ₈ "	16	5 - 6	4 ³ / ₄ "		17
Range 29	100 ³ / ₄ "	103 ⁷ / ₈ "	16	6	4 ³ / ₄ "	7 ⁷ / ₈ "	17
Range 30	104"	106 ⁵ / ₈ "	17	5 - 6	4 ³ / ₄ "		18
Range 31	106 ³ / ₄ "	109 ⁷ / ₈ "	17	6	4 ³ / ₄ "	7 ⁷ / ₈ "	18
Range 32	110"	112 ⁵ / ₈ "	18	5 - 6	4 ³ / ₄ "		19
Range 33	112 ³ / ₄ "	115 ⁷ / ₈ "	18	6	4 ³ / ₄ "	7 ⁷ / ₈ "	19
Range 34	116"	118 ⁵ / ₈ "	19	5 - 6	4 ³ / ₄ "		20
Range 35	118 ³ / ₄ "	120"	19	6	4 ³ / ₄ "	7 ⁷ / ₈ "	20

- White rows = built from top - down with 6" pleats, varying bottom pleat
- Shaded rows = built bottom - up with a fixed 4³/₄" bottom pleat/custom-spaced 5"-6" body pleats

*WARNING: For a uniform appearance for shades being used in same room, it is best to order within one range. If possible, choose length from white or grey row, but not both.

Pleat Break Points for PLAIN CLASSIC PLEATED CORDLESS Roman Shades for CORDLESS

Plain Classic Pleated CORDLESS Roman Shades						
	Length Range		Number of 6" Pleats	Varying Bottom Pleat Size Range		Total # of Pleats
	minimum	maximum		minimum	maximum	
Range 1	15 1/4"	21 1/8"	2	3 1/4"	9 1/8"	3
Range 2	21 1/4"	27 1/8"	3	3 1/4"	9 1/8"	4
Range 3	27 1/4"	33 1/8"	4	3 1/4"	9 1/8"	5
Range 4	33 1/4"	39 1/8"	5	3 1/4"	9 1/8"	6
Range 5	39 1/4"	45 1/8"	6	3 1/4"	9 1/8"	7
Range 6	45 1/4"	51 1/8"	7	3 1/4"	9 1/8"	8
Range 7	51 1/4"	57 1/8"	8	3 1/4"	9 1/8"	9
Range 8	57 1/4"	63 1/8"	9	3 1/4"	9 1/8"	10
Range 9	63 1/4"	69 1/8"	10	3 1/4"	9 1/8"	11
Range 10	69 1/4"	75 1/8"	11	3 1/4"	9 1/8"	12
Range 11	75 1/4"	81 1/8"	12	3 1/4"	9 1/8"	13
Range 12	81 1/4"	84"	13	3 1/4"	7"	14

• Built from top - down

Pleat Break Points for PLAIN CLASSIC PLEATED CORLDESS Roman Shades with RIBBON BANDING (on the edge & inset)

for CORDLESS

Plain Classic Pleated CORDLESS Roman Shades with Ribbon Banding							
	Length Range		Number of Pleats	Pleat Size	Varying Bottom Pleat Size Range		Total # of Pleats
	minimum	maximum			minimum	maximum	
Range 1	16 ³ / ₄ ''	19 ⁷ / ₈ ''	2	6	4 ³ / ₄ ''	7 ⁷ / ₈ ''	3
Range 2	20''	22 ⁵ / ₈ ''	3	5 - 6	4 ³ / ₄ ''		4
Range 3	22 ³ / ₄ ''	25 ⁷ / ₈ ''	3	6	4 ³ / ₄ ''	7 ⁷ / ₈ ''	4
Range 4	26''	28 ⁵ / ₈ ''	4	5 - 6	4 ³ / ₄ ''		5
Range 5	28 ³ / ₄ ''	31 ⁷ / ₈ ''	4	6	4 ³ / ₄ ''	7 ⁷ / ₈ ''	5
Range 6	32''	34 ⁵ / ₈ ''	5	5 - 6	4 ³ / ₄ ''		6
Range 7	34 ³ / ₄ ''	37 ⁷ / ₈ ''	5	6	4 ³ / ₄ ''	7 ⁷ / ₈ ''	6
Range 8	38''	40 ⁵ / ₈ ''	6	5 - 6	4 ³ / ₄ ''		7
Range 9	40 ³ / ₄ ''	43 ⁷ / ₈ ''	6	6	4 ³ / ₄ ''	7 ⁷ / ₈ ''	7
Range 10	44''	46 ⁵ / ₈ ''	7	5 - 6	4 ³ / ₄ ''		8
Range 11	46 ³ / ₄ ''	49 ⁷ / ₈ ''	7	6	4 ³ / ₄ ''	7 ⁷ / ₈ ''	8
Range 12	50''	52 ⁵ / ₈ ''	8	5 - 6	4 ³ / ₄ ''		9
Range 13	52 ³ / ₄ ''	55 ⁷ / ₈ ''	8	6	4 ³ / ₄ ''	7 ⁷ / ₈ ''	9
Range 14	56''	58 ⁵ / ₈ ''	9	5 - 6	4 ³ / ₄ ''		10
Range 15	58 ³ / ₄ ''	61 ⁷ / ₈ ''	9	6	4 ³ / ₄ ''	7 ⁷ / ₈ ''	10
Range 16	62''	64 ⁵ / ₈ ''	10	5 - 6	4 ³ / ₄ ''		11
Range 17	64 ³ / ₄ ''	67 ⁷ / ₈ ''	10	6	4 ³ / ₄ ''	7 ⁷ / ₈ ''	11
Range 18	68''	70 ⁵ / ₈ ''	11	5 - 6	4 ³ / ₄ ''		12
Range 19	70 ³ / ₄ ''	73 ⁷ / ₈ ''	11	6	4 ³ / ₄ ''	7 ⁷ / ₈ ''	12
Range 20	74''	76 ⁵ / ₈ ''	12	5 - 6	4 ³ / ₄ ''		13
Range 21	76 ³ / ₄ ''	79 ⁷ / ₈ ''	12	6	4 ³ / ₄ ''	7 ⁷ / ₈ ''	13
Range 22	80''	82 ⁵ / ₈ ''	13	5 - 6	4 ³ / ₄ ''		14
Range 23	82 ³ / ₄ ''	84 ''	13	6	4 ³ / ₄ ''	7 ⁷ / ₈ ''	14

- White rows = built from top - down with 6'' pleats, varying bottom pleat
- Shaded rows = built bottom - up with a fixed 4³/₄'' bottom pleat/custom-spaced 5''-6'' body pleats

*WARNING: For a uniform appearance for shades being used in same room, it is best to order within one range. If possible, choose length from white or grey row, but not both.

Pleat Break Points for FLAT FOLD Roman Shades

for Standard Cord Locks & CCO

Flat Fold Roman Shades with Ribbon Banding							
	Length Range		Fixed Bottom Pleat Size	Number of 6" Pleats	Varying Top Pleat Size Range		Total # of Pleats
	minimum	maximum			minimum	maximum	
Range 1	16"	20 5/8"	4 3/4"	1	3"	9 7/8"	3
Range 2	20 3/4"	26 5/8"	4 3/4"	2	3"	9 7/8"	4
Range 3	26 3/4"	32 5/8"	4 3/4"	3	3"	9 7/8"	5
Range 4	32 3/4"	38 5/8"	4 3/4"	4	3"	9 7/8"	6
Range 5	38 3/4"	44 5/8"	4 3/4"	5	3"	9 7/8"	7
Range 6	44 3/4"	50 5/8"	4 3/4"	6	3"	9 7/8"	8
Range 7	50 3/4"	56 5/8"	4 3/4"	7	3"	9 7/8"	9
Range 8	56 3/4"	62 5/8"	4 3/4"	8	3"	9 7/8"	10
Range 9	62 3/4"	68 5/8"	4 3/4"	9	3"	9 7/8"	11
Range 10	68 3/4"	74 5/8"	4 3/4"	10	3"	9 7/8"	12
Range 11	74 3/4"	80 5/8"	4 3/4"	11	3"	9 7/8"	13
Range 12	80 3/4"	86 5/8"	4 3/4"	12	3"	9 7/8"	14
Range 13	86 3/4"	92 5/8"	4 3/4"	13	3"	9 7/8"	15
Range 14	92 3/4"	98 5/8"	4 3/4"	14	3"	9 7/8"	16
Range 15	98 3/4"	104 5/8"	4 3/4"	15	3"	9 7/8"	17
Range 16	104 3/4"	110 5/8"	4 3/4"	16	3"	9 7/8"	18
Range 17	110 3/4"	116 5/8"	4 3/4"	17	3"	9 7/8"	19
Range 18	116 3/4"	120"	4 3/4"	18	3"	7 1/4"	20

Pleat Break Diagrams

- Built from bottom - up
- Useful for different size windows which are next to each other
- The top pleat will vary from 3" to 9 7/8"

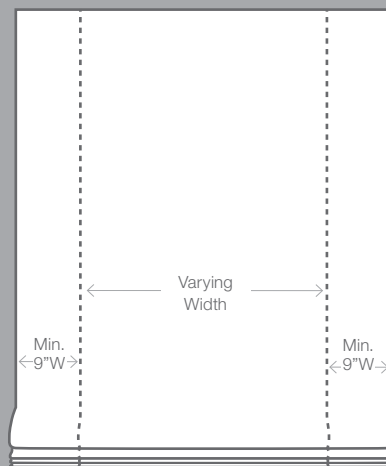
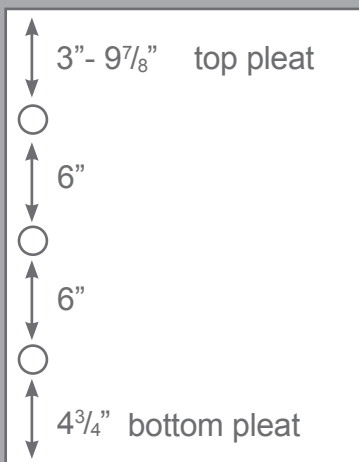
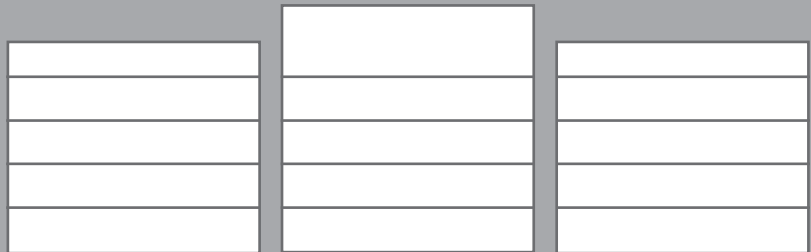

Seamed Roman Shades

- Seamless Roman Shades are available up to a maximum of 48" wide. Beyond 48" wide, shades will be made with a varying width center panel and side panels seamed to a minimum of 9" wide on both sides.

Pleat Break Points for FLAT FOLD Roman Shades with RIBBON BANDING (on the edge & inset)

for Standard Cord Locks & CCO

Flat Fold Roman Shades with Ribbon Banding							
	Length Range		Fixed Bottom Pleat Size	Number of 6" Pleats	Varying Top Pleat Size Range		Total # of Pleats
	minimum	maximum			minimum	maximum	
Range 1	16"	20 5/8"	4 3/4"	1	3"	9 7/8"	3
Range 2	20 3/4"	26 5/8"	4 3/4"	2	3"	9 7/8"	4
Range 3	26 3/4"	32 5/8"	4 3/4"	3	3"	9 7/8"	5
Range 4	32 3/4"	38 5/8"	4 3/4"	4	3"	9 7/8"	6
Range 5	38 3/4"	44 5/8"	4 3/4"	5	3"	9 7/8"	7
Range 6	44 3/4"	50 5/8"	4 3/4"	6	3"	9 7/8"	8
Range 7	50 3/4"	56 5/8"	4 3/4"	7	3"	9 7/8"	9
Range 8	56 3/4"	62 5/8"	4 3/4"	8	3"	9 7/8"	10
Range 9	62 3/4"	68 5/8"	4 3/4"	9	3"	9 7/8"	11
Range 10	68 3/4"	74 5/8"	4 3/4"	10	3"	9 7/8"	12
Range 11	74 3/4"	80 5/8"	4 3/4"	11	3"	9 7/8"	13
Range 12	80 3/4"	86 5/8"	4 3/4"	12	3"	9 7/8"	14
Range 13	86 3/4"	92 5/8"	4 3/4"	13	3"	9 7/8"	15
Range 14	92 3/4"	98 5/8"	4 3/4"	14	3"	9 7/8"	16
Range 15	98 3/4"	104 5/8"	4 3/4"	15	3"	9 7/8"	17
Range 16	104 3/4"	110 5/8"	4 3/4"	16	3"	9 7/8"	18
Range 17	110 3/4"	116 5/8"	4 3/4"	17	3"	9 7/8"	19
Range 18	116 3/4"	120"	4 3/4"	18	3"	7 1/4"	20

Pleat Break Diagrams

- Built from bottom - up
- Useful for different size windows which are next to each other
- **The top pleat will vary from 3" to 9 7/8"**

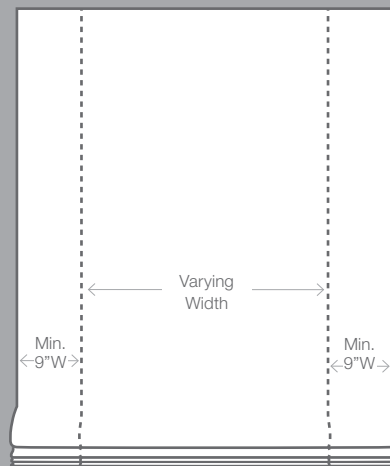
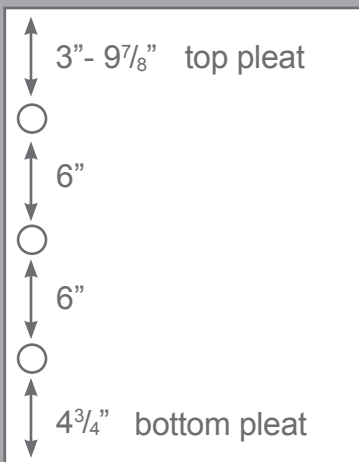
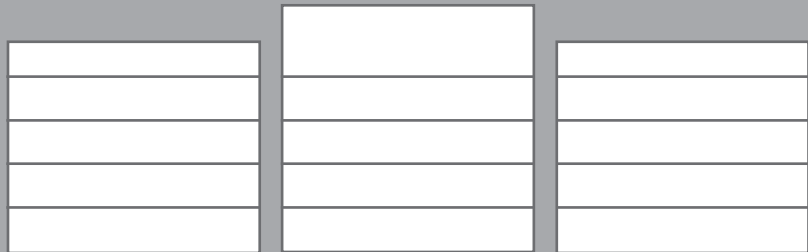

Seamed Roman Shades

- Seamless Roman Shades are available up to a maximum of 48" wide. Beyond 48" wide, shades will be made with a varying width center panel and side panels seamed to a minimum of 9" wide on both sides.

Pleat Break Points for EUROPEAN/RELAXED Roman Shades

for Standard Cord Locks & CCO

European/Relaxed Roman Shades							
	Length Range		Fixed Bottom Pleat Size	Number of 6" Pleats	Varying Top Pleat Size Range		Total # of Pleats
	minimum	maximum			minimum	maximum	
Range 1	16"	19 $\frac{7}{8}$ "	4"	1	3"	9 $\frac{7}{8}$ "	3
Range 2	20"	25 $\frac{7}{8}$ "	4"	2	3"	9 $\frac{7}{8}$ "	4
Range 3	26"	31 $\frac{7}{8}$ "	4"	3	3"	9 $\frac{7}{8}$ "	5
Range 4	32"	37 $\frac{7}{8}$ "	4"	4	3"	9 $\frac{7}{8}$ "	6
Range 5	38"	43 $\frac{7}{8}$ "	4"	5	3"	9 $\frac{7}{8}$ "	7
Range 6	44"	49 $\frac{7}{8}$ "	4"	6	3"	9 $\frac{7}{8}$ "	8
Range 7	50"	55 $\frac{7}{8}$ "	4"	7	3"	9 $\frac{7}{8}$ "	9
Range 8	56"	61 $\frac{7}{8}$ "	4"	8	3"	9 $\frac{7}{8}$ "	10
Range 9	62"	67 $\frac{7}{8}$ "	4"	9	3"	9 $\frac{7}{8}$ "	11
Range 10	68"	73 $\frac{7}{8}$ "	4"	10	3"	9 $\frac{7}{8}$ "	12
Range 11	74"	79 $\frac{7}{8}$ "	4"	11	3"	9 $\frac{7}{8}$ "	13
Range 12	80"	85 $\frac{7}{8}$ "	4"	12	3"	9 $\frac{7}{8}$ "	14
Range 13	86"	91 $\frac{7}{8}$ "	4"	13	3"	9 $\frac{7}{8}$ "	15
Range 14	92"	97 $\frac{7}{8}$ "	4"	14	3"	9 $\frac{7}{8}$ "	16
Range 15	98"	103 $\frac{7}{8}$ "	4"	15	3"	9 $\frac{7}{8}$ "	17
Range 16	104"	109 $\frac{7}{8}$ "	4"	16	3"	9 $\frac{7}{8}$ "	18
Range 17	110"	115 $\frac{7}{8}$ "	4"	17	3"	9 $\frac{7}{8}$ "	19
Range 18	116"	120"	4"	18	3"	8"	20

Pleat Break Diagrams

- Built from bottom - up
- Useful for different size windows which are next to each other
- **The top pleat will vary from 3" to 9 $\frac{7}{8}$ "**

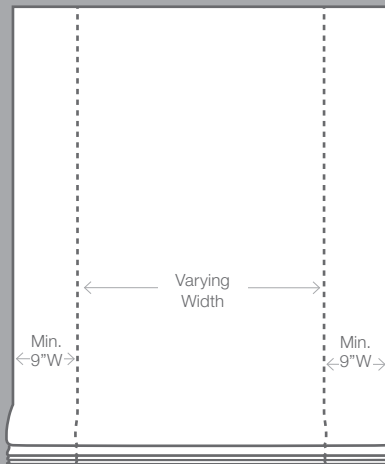
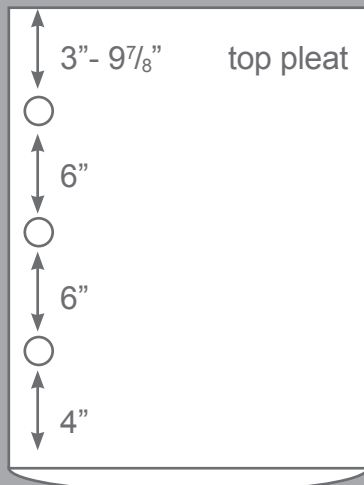

Seamed Roman Shades

- Seamless Roman Shades are available up to a maximum of 48" wide. Beyond 48" wide, shades will be made with a varying width center panel and side panels seamed to a minimum of 9" wide on both sides.

Pleat Break Points for FRONT SLATS Roman Shades

for Standard Cord Locks & CCO

Front Slats Roman Shades						
	Length Range		Number of 6" Pleats	Varying Bottom Pleat Size Range		Total # of Pleats
	minimum	maximum		minimum	maximum	
Range 1	16"	19 7/8"	2	4"	7 7/8"	3
Range 2	20"	25 7/8"	3	2"	7 7/8"	4
Range 3	26"	31 7/8"	4	2"	7 7/8"	5
Range 4	32"	37 7/8"	5	2"	7 7/8"	6
Range 5	38"	43 7/8"	6	2"	7 7/8"	7
Range 6	44"	49 7/8"	7	2"	7 7/8"	8
Range 7	50"	55 7/8"	8	2"	7 7/8"	9
Range 8	56"	61 7/8"	9	2"	7 7/8"	10
Range 9	62"	67 7/8"	10	2"	7 7/8"	11
Range 10	68"	73 7/8"	11	2"	7 7/8"	12
Range 11	74"	79 7/8"	12	2"	7 7/8"	13
Range 12	80"	85 7/8"	13	2"	7 7/8"	14
Range 13	86"	91 7/8"	14	2"	7 7/8"	15
Range 14	92"	97 7/8"	15	2"	7 7/8"	16
Range 15	98"	103 7/8"	16	2"	7 7/8"	17
Range 16	104"	109 7/8"	17	2"	7 7/8"	18
Range 17	110"	115 7/8"	18	2"	7 7/8"	19
Range 18	116"	120"	19	2"	6"	20

Pleat Break Diagrams

- Built from top - down
- Useful for different size windows which are next to each other
- **The bottom pleat will vary from 2" to 7 7/8"**

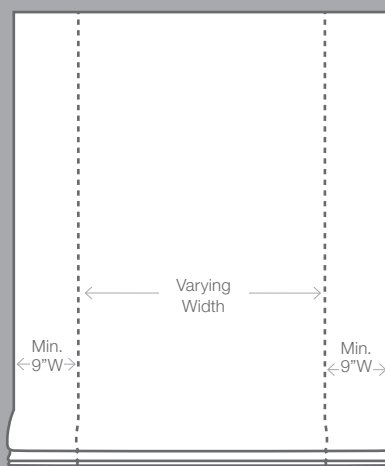
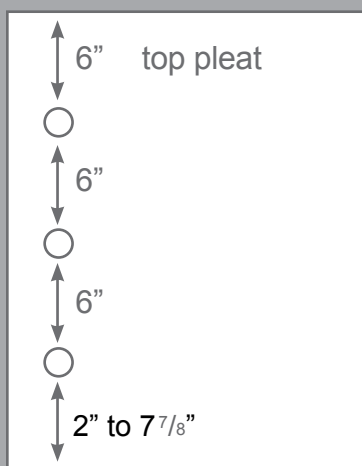
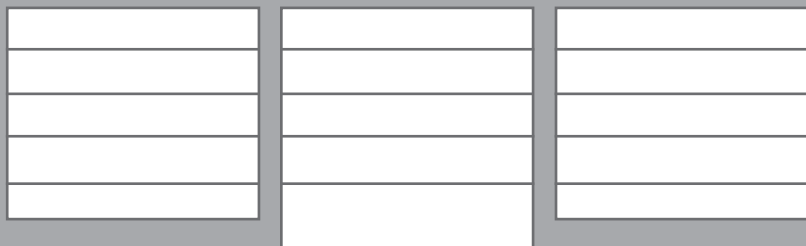

Seamed Roman Shades

- Seamless Roman Shades are available up to a maximum of 48" wide. Beyond 48" wide, shades will be made with a varying width center panel and side panels seamed to a minimum of 9" wide on both sides.



DRAPERY PANELS

Made-to-Measure Curtains & Drapery Panels offer simplicity with a soft edge. Offered in the best selling styles.

inner grommet panels: tulsa/matka silk, ash
outer grommet panels: tulsa/matka silk, pewter
with plain classic pleated TDBU roman shade: melodie/toile paisley, platinum

DRAPERY STYLES

Pre-Set or Precise Width, Fabrics or Sheers

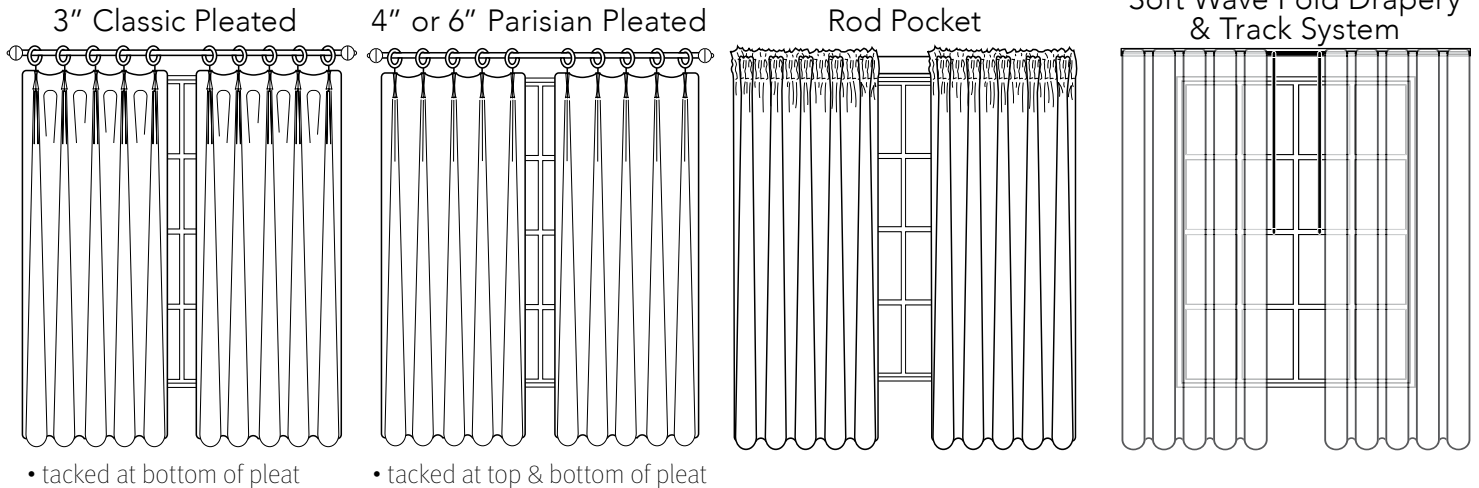

Pre-Set Width, Sheer Sheer Door Panels

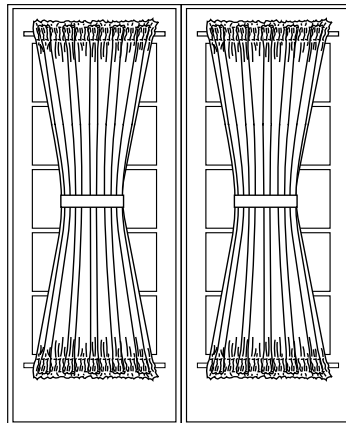

Pre-Set Width, Fabrics only

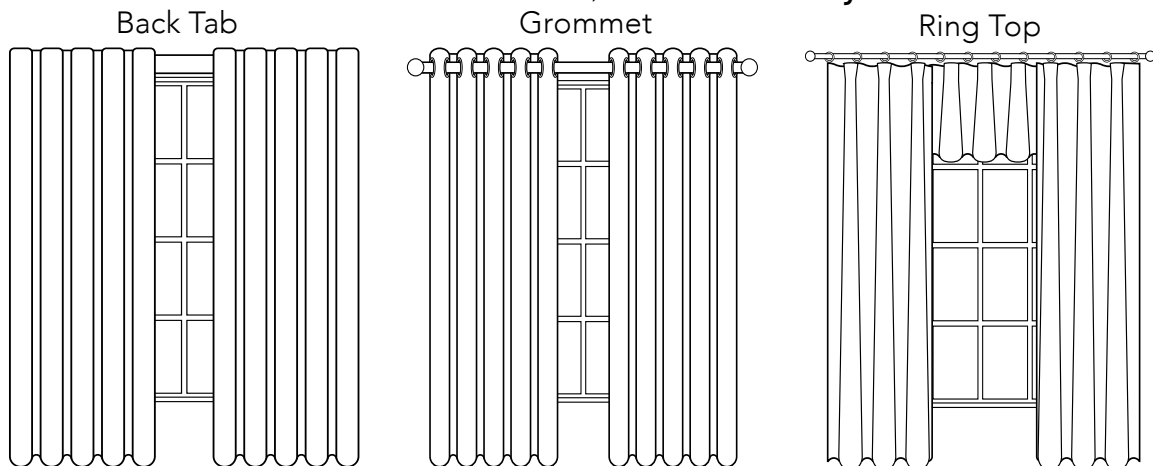

* Panels & coordinating valances come standard unlined. Upgrade to Standard, Thermal Sateen, Room Darkening or Premium Blackout.

> **6"L or 4"L Parisian and
3" Classic, triple fold pleats available**

- > Available in 7 pre-set widths or precise widths:
 - single panels/one-way draw to cover window widths up to 96"W
 - pair of panels/two-way draw to cover window widths up to 192"W
- > Made with a minimum of 200% fullness
- > **See Price & Spec Guide for # of Pleats table**
- > 3 pre-pinned setting options (illustration on p.48):
 - Decorative Rod (1/2" down from top)
 - Ceiling (1 1/4" down from top)
 - Traverse Rod (1 3/4" down from top)



- > **Coordinating Valances** are ordered separately
- > Choose from 4 pre-set widths: 24"W, 48"W, 72"W or 96" W x 18" L or choose precise widths to cover up to 96"W
- > No trim upgrades available for Coordinating Valances
- > All coordinated products made of the same fabric should use the same lining



- > **Contoured Tiebacks** are ordered separately as a pair, in 3 sizes
- > Tiebacks may be upgraded with decorative cord or fringe on the bottom edge for a more custom look (see pages 79-81 for options)
- > **For additional spec info, see p.46-49**

pleat style options

3" classic pleat



> tacked bottom only

4" parisian pleat



> tacked top & bottom

6" parisian pleat



> tacked top & bottom



4" parisian pleated panels (unlined):
rio/faux linen, putty

FABRIC PLEATED PANELS

6" parisian pleated panels: camelot/silkesse, antique
with soft fold/hobbled roman shade: rio/faux linen, putty

SHEER PLEATED PANELS

- > **Sheer materials:**
 - Voile - snow & ivory
 - Crepe - snow & ivory
 - Misty/Semi-Opaque - snow & ivory
- > For additional spec info, see p.46-49

- > 6"L or 4"L Parisian and 3" Classic, triple fold pleats available
- > Available in 7 pre-set widths or precise widths:
 - single panels/one-way draw to cover window widths up to 96"W
 - pair of panels/two-way draw to cover window widths up to 192"W
- > Made with a minimum of 300% fullness
- > **See Price & Spec Guide for # of Pleats table**
- > 3 pre-pinned setting options (illustration on p.48):
 - Decorative Rod (1/2" down from top)
 - Ceiling (1 1/4" down from top)
 - Traverse Rod (1 3/4" down from top)
- > **Maximum length: 106"L**

pleat style options

3" classic pleat



> tacked bottom only

4" parisian pleat



> tacked top & bottom

6" parisian pleat



> tacked top & bottom



sheer 6" parisian pleat panels: crepe, ivory

SHEER ROD POCKET PANELS

- > Available in 7 pre-set widths or precise widths:
 - single panels/one-way draw to cover window widths up to 96"W
 - pair of panels/two-way draw to cover window widths up to 192"W
- > Pocket / Header options available:
 - For use with $\frac{3}{4}$ " maximum diameter rod:**
 - 1 $\frac{1}{2}$ " pocket / 1 $\frac{1}{2}$ " header
 - 1 $\frac{1}{2}$ " pocket / no header
 - For use with 1 $\frac{1}{4}$ " max. diameter decorative rods, or 2 $\frac{1}{2}$ " basic rod:**
 - 3" pocket / 3" header
 - 3" pocket / no header
- > **Maximum length: 108"L**
 - 1 $\frac{1}{2}$ " pocket / no header

- > **Sheer materials:**

- Voile - snow & ivory
- Crepe - snow & ivory
- Misty/Semi-Opaque - snow & ivory



sheer rod pocket panel:
crepe, ivory 1 $\frac{1}{2}$ " pocket / 1 $\frac{1}{2}$ "
header on 1" single basic rod



sheer rod pocket panels: crepe, ivory with
6" parisian pleat panels: camelot/silkesse, tussah

> For additional spec info, see p.50-51

- > Available in 7 pre-set widths or precise widths:
 - single panels/one-way draw to cover window widths up to 96"W
 - pair of panels/two-way draw to cover window widths up to 192"W
- > Pocket / Header options available:
 - For use with 3/4" maximum diameter rod:**
 - 1 1/2" pocket / 1 1/2" header
 - 1 1/2" pocket / no header
 - For use with 1 1/4" max. diameter decorative rods, or 2 1/2" basic rod:**
 - 3" pocket / 3" header
 - 3" pocket / no header



- > **Coordinating Valances** are ordered separately
- > Choose from 4 pre-set widths: 50"W, 100"W, 150"W or 200" W x 18" L or choose precise widths to cover up to 96"W
- > No trim upgrades available for Coordinating Valances
- > All coordinated products made of the same fabric should use the same lining



- > **Contoured Tiebacks** are ordered separately as a pair, available in 3 sizes
- > Tiebacks may be upgraded with decorative cord or fringe on the bottom edge for a more custom look (see pages 79-81 for options)
- > **For additional spec info, see p.50-51**

ROD POCKET PANELS

rod pocket panels with coordinating valance: camelot/silkesse, sangria

BACK TAB PANELS



back tab panels: camelot/silkesse, sangria

- > Available in pre-set widths only
- > 4"L x 2"W tabs spaced approximately 9" from tab center to next tab center



back tab panels: lexi/drapeable flannel, sky

- > **Coordinating Valances** are ordered separately
- > Choose from 4 pre-set widths: 50"W, 100"W, 150"W or 200" W x 18" L
- > No trim upgrades available for Coordinating Valances
- > All coordinated products made of the same fabric should use the same lining



- > **Contoured Tiebacks** are ordered separately as a pair, available in 3 sizes
- > Tiebacks may be upgraded with decorative cord or fringe on the bottom edge for a more custom look (see pages 79-81 for options)
- > **For additional spec info, see p.52**

- > Available in pre-set widths only
- > Ring Top Panels are for use with decorative hardware (choose ring color and finish and coordinating 1 1/4" rod from hardware collection on p.78)
- > Rings are offered in 3 finishes:
 - oil rubbed bronze, satin nickel & antique brass
- > Rings are sewn onto the top of the panel. Rings will be included in the length ordered
- > Optional C-Rings & Passing Brackets are available for an upcharge, including the appropriate number of passing brackets for the drapery width ordered (see p.78). Recommended for 100" or wider.
- > Our recommendations allow for an approximate 2.25 : 1 fullness
- > Bottom hem is 4"
- > Side hems are 1.5"

ring finishes



antique brass



oil rubbed bronze



satin nickel



- > **Coordinating Valances** are ordered separately
- > Choose from 4 pre-set widths: 50"W, 100"W, 150"W or 200" W x 18" L
- > No trim upgrades available for Coordinating Valances
- > All coordinated products made of the same fabric should use the same lining

- > **Contoured Tiebacks** are ordered separately as a pair, available in 3 sizes
- > Tiebacks may be upgraded with decorative cord or fringe on the bottom edge for a more custom look (see pages 79-81 for options)
- > **For additional spec info, see p.53**

RING TOP PANELS

ring top panels with coordinating valance: wilmington/cotton duck, natural

GROMMET PANELS

** NOTE: Grommet Panels on Double Rod system featured above do not slide easily. It is best used as a decorative stationary side panel ensemble.*

**two pairs of grommet panels on a double-bracket rod system
inner grommet panels: lucky/cotton sateen, silver
outer grommet panels: camelot/silkesse oxford
with soft fold/hobbled roman shade: lucky/cotton sateen, silver**



two pairs of grommet panels on a single rod
 inner grommet panels: tulsa/matka silk, ash
 outer grommet panels: tulsa/matka silk, pewter



grommet panels:
 wilmington/cotton duck, caliente

- > Grommets are offered in 3 finishes:
 oil rubbed bronze, satin nickel & antique brass
- > Grommet sizes:
 outer diameter - 2 1/2", inner diameter - 1 1/2"
- > Only rods & poles 1 1/4" diameter and less can
 be used to hang these grommet panels

grommet finishes



antique brass oil rubbed bronze satin nickel



- > **Coordinating Valances** are ordered separately
- > Choose from 4 pre-set widths: 50"W, 100"W, 150"W or 200" W x 18" L
- > No trim upgrades available for Coordinating Valances
- > All coordinated products made of the same fabric should use the same lining
- > Bottom hem is 1.5". Side hems are 0.5"



- > **Contoured Tiebacks** are ordered separately
 as a pair, available in 3 sizes
- > Tiebacks may be upgraded with decorative
 cord or fringe on the bottom edge for a more
 custom look (see pages 79-81 for options)

> **For additional spec info, see p.54**

Available as single panels/one-way draw or pairs of panels/two-way draw.

- > Available in precise widths only, made with 180% fullness (1.8:1 fullness):
 - single panels/one-way draw to cover window widths up to 104"W
 - pair of panels/two-way draw to cover window widths up to 208"W
- > Batons are included for moving panels - cut to the 1/2"
- > If ceiling-mounted double track is needed, use two single ceiling-mounted brackets, one in front of the other

single panel/one-way draw		
minimum & maximum widths & lengths		
	minimum	maximum
width	23"W	104"W
length	24"L	120"L

pair of panels/two-way draw		
minimum & maximum widths & lengths		
	minimum	maximum
width	23"W	208"W
length	24"L	120"L

track is included in length, cut precisely to the 1/2"

> For additional spec info, see p.55-57



- > Metal post tape is attached to top of panels and snaps into carriers on the track
 - Metal post tape may be visible at top of drapery, particularly on sheers
- > Note: 1/4" light gap exists between top of drapery and track.
- > All coordinated products made of the same fabric should use the same lining



soft wave fold drapery panels/single track system: gent/linen blend solid, flax

SOFT WAVE FOLD DRAPERIES & TRACK SYSTEM

soft wave fold drapery panels (front track): ikat ombre horizontal stripe, coconut
soft wave fold drapery panels (back track): raw silk crepe/linen sheer look, pebble
with front slats roman shade: lexi/drapeable flannel, chino

Pleated Panel Sizing Solutions for pre-set widths for all fabrics and sheers

charts for use with decorative hardware & rings or traversing hardware
(chart accounts for standard 4" overlaps & 4" returns)

PRE-SET PLEATED PANELS
INCLUDE 4" RETURNS

FULL CLOSURE FABRIC PANELS - approximately 2:1 fullness							
	Pre-Set Widths Available						
Total Width To Cover:	24"W	36"W	48"W	60"W	72"W	84"W	96"W
# of pleats per panel	5	8	11	14	17	20	23
# of rings needed per panel	7	10	13	16	19	22	25
14" - 36" W	2	or	1				
37" - 60" W		2	or		1		
61" - 84" W			2		or		1
85" - 108" W				2			
109" - 132" W					2		
133" - 156" W						2	
157" - 180" W							2

STATIONARY FABRIC SIDE PANELS - approximately 2:1 fullness							
	Pre-Set Widths Available						
Total Width To Cover:	24"W	36"W	48"W	60"W	72"W	84"W	96"W
# of pleats per panel	5	8	11	14	17	20	23
# of rings needed per panel	7	10	13	16	19	22	25
24" - 48" W	2	or	1				
49" - 72" W		2	or		1		
73" - 96" W			2		or		1
97" - 120" W				2			
121" - 144" W					2		
145" - 168" W						2	
169" - 192" W							2

FULL CLOSURE SHEER PANELS - approximately 3:1 fullness							
	Pre-Set Widths Available						
Total Width To Cover:	24"W	36"W	48"W	60"W	72"W	84"W	96"W
# of pleats per panel	6	11	15	19	24	28	33
# of rings needed per panel	8	13	17	21	26	30	35
14" - 36" W	2	or	1				
37" - 60" W		2	or		1		
61" - 84" W			2		or		1
85" - 108" W				2			
109" - 132" W					2		
133" - 156" W						2	
157" - 180" W							2

STATIONARY SHEER SIDE PANELS - approximately 3:1 fullness							
	Pre-Set Widths Available						
Total Width To Cover:	24"W	36"W	48"W	60"W	72"W	84"W	96"W
# of pleats per panel	6	11	15	19	24	28	33
# of rings needed per panel	8	13	17	21	26	30	35
24" - 48" W	2	or	1				
49" - 72" W		2	or		1		
73" - 96" W			2		or		1
97" - 120" W				2			
121" - 144" W					2		
145" - 168" W						2	
169" - 192" W							2

SIZING SOLUTIONS

Contoured Tiebacks for Pre-Set Widths Pleated Panels

pre-set width \ tieback sizes		Small	Medium	Large
		5"W x 26"L	5"W x 33"L	5"W x 44"L
Small	24"W	x		
	36"W	x		
	48"W	x		
Medium	60"W		x	
	72"W		x	
Large	84"W			x
	96"W			x

Contoured Tiebacks for Precise Widths Pleated Panels

pre-set width \ tieback sizes		Small	Medium	Large
		5"W x 26"L	5"W x 33"L	5"W x 44"L
Small	24"W	x		
	36"W	x		
	48"W	x		
Medium	60"W		x	
	72"W		x	
Large	84"W			x
	96"W			x

Pre-Pinning Info

3 pre-pinned setting options:

- Decorative Rod (1/2" down from top)
- Ceiling (1 1/4" down from top)
- Traverse Rod (1 3/4" down from top)

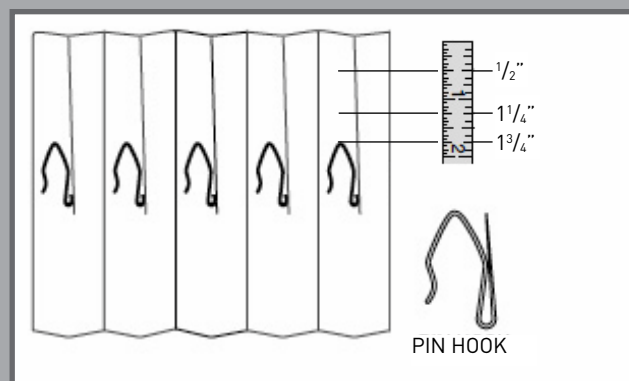

Precise Widths Pleated Panels number of pleats based on widths ordered

FABRIC Pleated Panels

SHEER Pleated Panels

Single Panel WITH RETURNS		Single Panel WITHOUT RETURNS	
Face Width	Pleats	Face Width	Pleats
17" - 19 ⁷ / ₈ "	4	17" - 19 ⁷ / ₈ "	3
20" - 23 ⁷ / ₈ "	5	20" - 23 ⁷ / ₈ "	4
24" - 27 ⁷ / ₈ "	6	24" - 27 ⁷ / ₈ "	5
28" - 31 ⁷ / ₈ "	7	28" - 31 ⁷ / ₈ "	6
32" - 35 ⁷ / ₈ "	8	32" - 35 ⁷ / ₈ "	7
36" - 39 ⁷ / ₈ "	9	36" - 39 ⁷ / ₈ "	8
40" - 43 ⁷ / ₈ "	10	40" - 43 ⁷ / ₈ "	9
44" - 47 ⁷ / ₈ "	11	44" - 47 ⁷ / ₈ "	10
48" - 51 ⁷ / ₈ "	12	48" - 51 ⁷ / ₈ "	11
52" - 55 ⁷ / ₈ "	13	52" - 55 ⁷ / ₈ "	12
56" - 59 ⁷ / ₈ "	14	56" - 59 ⁷ / ₈ "	13
60" - 63 ⁷ / ₈ "	15	60" - 63 ⁷ / ₈ "	14
64" - 67 ⁷ / ₈ "	16	64" - 67 ⁷ / ₈ "	15
68" - 71 ⁷ / ₈ "	17	68" - 71 ⁷ / ₈ "	16
72" - 75 ⁷ / ₈ "	18	72" - 75 ⁷ / ₈ "	17
76" - 79 ⁷ / ₈ "	19	76" - 79 ⁷ / ₈ "	18
80" - 83 ⁷ / ₈ "	20	80" - 83 ⁷ / ₈ "	19
84" - 87 ⁷ / ₈ "	21	84" - 87 ⁷ / ₈ "	20
88" - 96"	22	88" - 91 ⁷ / ₈ "	21
		92" - 96"	22

Single Panel WITH RETURNS		Single Panel WITHOUT RETURNS	
Face Width	Pleats	Face Width	Pleats
12" - 13 ¹¹ / ₁₆ "	4	12" - 13 ⁷ / ₁₆ "	2
13 ³ / ₄ " - 16 ⁷ / ₁₆ "	5	13 ¹ / ₂ " - 16 ¹ / ₈ "	3
16 ¹ / ₂ " - 19 ¹ / ₈ "	6	16 ¹ / ₄ " - 18 ⁵ / ₁₆ "	4
19 ¹ / ₄ " - 21 ⁵ / ₁₆ "	7	19" - 21 ¹¹ / ₁₆ "	5
22" - 24 ¹¹ / ₁₆ "	8	21 ³ / ₄ " - 24 ⁷ / ₁₆ "	6
24 ³ / ₄ " - 27 ¹ / ₁₆ "	9	24 ¹ / ₂ " - 27 ¹ / ₈ "	7
27 ¹ / ₂ " - 30 ¹ / ₈ "	10	27 ¹ / ₄ " - 29 ⁵ / ₁₆ "	8
30 ¹ / ₄ " - 32 ⁵ / ₁₆ "	11	30" - 32 ¹¹ / ₁₆ "	9
33" - 35 ¹¹ / ₁₆ "	12	32 ³ / ₄ " - 35 ⁷ / ₁₆ "	10
35 ³ / ₄ " - 38 ⁷ / ₁₆ "	13	35 ¹ / ₂ " - 38 ¹ / ₈ "	11
38 ¹ / ₂ " - 41 ¹ / ₈ "	14	38 ¹ / ₄ " - 40 ⁵ / ₁₆ "	12
41 ¹ / ₄ " - 43 ⁵ / ₁₆ "	15	41" - 43 ¹¹ / ₁₆ "	13
44" - 46 ¹¹ / ₁₆ "	16	43 ³ / ₄ " - 46 ⁷ / ₁₆ "	14
46 ³ / ₄ " - 49 ¹ / ₁₆ "	17	46 ¹ / ₂ " - 49 ¹ / ₈ "	15
49 ¹ / ₂ " - 52 ¹ / ₈ "	18	49 ¹ / ₄ " - 51 ⁵ / ₁₆ "	16
52 ¹ / ₄ " - 54 ⁵ / ₁₆ "	19	52" - 54 ¹¹ / ₁₆ "	17
55" - 57 ¹¹ / ₁₆ "	20	54 ³ / ₄ " - 57 ⁷ / ₁₆ "	18
57 ³ / ₄ " - 60 ⁷ / ₁₆ "	21	57 ¹ / ₂ " - 60 ¹ / ₈ "	19
60 ¹ / ₂ " - 63 ¹ / ₈ "	22	60 ¹ / ₄ " - 62 ⁵ / ₁₆ "	20
63 ¹ / ₄ " - 65 ⁵ / ₁₆ "	23	63" - 65 ¹¹ / ₁₆ "	21
66" - 68 ¹¹ / ₁₆ "	24	65 ³ / ₄ " - 68 ⁷ / ₁₆ "	22
68 ³ / ₄ " - 71 ¹ / ₁₆ "	25	68 ¹ / ₂ " - 71 ¹ / ₈ "	23
71 ¹ / ₂ " - 74 ¹ / ₈ "	26	71 ¹ / ₄ " - 73 ⁵ / ₁₆ "	24
74 ¹ / ₄ " - 76 ⁵ / ₁₆ "	27	74" - 76 ¹¹ / ₁₆ "	25
77" - 79 ¹¹ / ₁₆ "	28	76 ³ / ₄ " - 79 ⁷ / ₁₆ "	26
79 ³ / ₄ " - 82 ⁷ / ₁₆ "	29	79 ¹ / ₂ " - 82 ¹ / ₈ "	27
82 ¹ / ₂ " - 85 ¹ / ₈ "	30	82 ¹ / ₄ " - 84 ⁵ / ₁₆ "	28
85 ¹ / ₄ " - 87 ⁵ / ₁₆ "	31	85" - 87 ¹¹ / ₁₆ "	29
88" - 90 ¹¹ / ₁₆ "	32	87 ³ / ₄ " - 90 ⁷ / ₁₆ "	30
90 ³ / ₄ " - 93 ⁷ / ₁₆ "	33	90 ¹ / ₂ " - 93 ¹ / ₈ "	31
93 ¹ / ₂ " - 96"	34	93 ¹ / ₄ " - 95 ⁵ / ₁₆ "	32
		96	33

Note • From 96¹/₈" - 192", must be 2-way draw
 • To determine the number of pleats for 2-way draw/split draw, take total face width divided by 2, look up number of pleats per panel

SIZING SOLUTIONS for Rod Pocket FABRICS

Rod Pocket Panel Sizing Solutions - for pre-set widths for FABRICS

- Our recommendations allow for an approximate 2.25 : 1 fullness
- Bottom hem is 4"
- Side hems are 1.5"
- Pocket / Header options available:
 - For use with $\frac{3}{4}$ " maximum diameter rod:
 - 1 $\frac{1}{2}$ " Pocket / 1 $\frac{1}{2}$ " Header
 - 1 $\frac{1}{2}$ " Pocket / No Header
 - For use with 1 $\frac{1}{4}$ " max. diameter decorative rods or 2 $\frac{1}{2}$ " basic rod:
 - 3" Pocket / 3" Header
 - 3" Pocket / No Header

Total Width to Cover:		Pre-Set Widths Available						
		50"W	75"W	100"W	125"W	150"W	175"W	200"W
30"- 40"W	Use this # of Panels	2	or	1				
41"- 60"W		2		or	1			
61"- 80"W				2		or		1
81"- 100"W		2						
101"- 120"W						2		
121"- 140"W					2			
141"- 160"W								2

Contoured Tiebacks for Pre-Set Width Rod Pocket Panels

pre-set width \ tieback sizes		Small	Medium	Large
		5"W x 26"L	5"W x 33"L	5"W x 44"L
Small	50"W	x		
	75"W	x		
	100"W	x		
Medium	125"W		x	
	150"W		x	
Large	175"W			x
	200"W			x

Contoured Tiebacks for Precise Width Rod Pocket Panels

pre-set width \ tieback sizes		Small	Medium	Large
		5"W x 26"L	5"W x 33"L	5"W x 44"L
Small	50"W	x		
	75"W	x		
	100"W	x		
Medium	125"W		x	
	150"W		x	
Large	175"W			x
	200"W			x

SIZING SOLUTIONS for Rod Pocket SHEERS

Rod Pocket Panel Sizing Solutions - for pre-set widths for SHEERS

- Pocket / Header options available:
For use with $\frac{3}{4}$ " maximum diameter rod:
- 1½" Pocket / 1½" Header
- 1½" Pocket / No Header
For use with 1¼" max. diameter decorative rods
or 2½" basic rod:
- 3" Pocket / 3" Header
- 3" Pocket / No Header
- Sheer materials available in 7 pre-set widths:
Voile - Snow & Ivory
Crepe - Snow & Ivory
Misty - Snow & Ivory
- Made to length to the 1/2" up to 108" long maximum
- Our pre-set width sheers allow for an approximate 3 : 1 fullness.

		Pre-Set Widths Available						
Total Width to Cover:		50"W	75"W	100"W	125"W	150"W	175"W	200"W
24"- 33.5"W	Use this # of Panels	2	or	1				
33.5"- 50"W		2		or	1			
50"- 66.5"W				2		or		1
66.5"- 83.5"W		2						
83.5"- 100"W						2		
100"- 116.5"W		2						
116.5"- 133.5"W								2

SIZING SOLUTIONS

Back Tab Panel Sizing Solutions - for pre-set widths

- Our recommendations allow for an approximate minimum of 2.25 : 1 fullness
- Bottom hem is 4"
- Side hems are 1.5"
- 4"L x 2"W tabs spaced approximately 9" from tab center to next tab center

Total Width to Cover:		Pre-Set Widths Available						
		50"W	75"W	100"W	125"W	150"W	175"W	200"W
30"- 40"W	Use this # of Panels	2	or	1				
41"- 60"W		2		or	1			
61"- 80"W				2		or		1
81"- 100"W					2			
101"- 120"W						2		
121"- 140"W						2		
141"- 160"W								2

Contoured Tiebacks for Pre-Set Width Back Tab Panels

pre-set width	tieback sizes	Small	Medium	Large
		5"W x 26"L	5"W x 33"L	5"W x 44"L
Small	50"W	x		
	75"W	x		
	100"W	x		
Medium	125"W		x	
	150"W		x	
Large	175"W			x
	200"W			x

SIZING SOLUTIONS

Ring Top Panel Sizing Solutions - for pre-set widths

- Our recommendations allow for an approximate 2.25 : 1 fullness
- Bottom hem is 4"
- Side hems are 1.5"
- Rings are sewn onto the top of the panel. Ring will be included in the length ordered.
- Ring Top Panels are for use with decorative hardware (choose ring color and finish and coordinating 1 1/4" rod from hardware collection on p.78)

Pre-Set Widths Available								
Total Width to Cover:	50"W	75"W	100"W	125"W	150"W	175"W	200"W	
# of rings per panel:	6	9	12	15	18	21	24	
30"- 40"W	Use this # of Panels	2	or	1				
41"- 60"W		2		or	1			
61"- 80"W				2		or		1
81"- 100"W		2						
101"- 120"W						2		
121"- 140"W		2						
141"- 160"W								2

Contoured Tiebacks for Pre-Set Width Ring Top Panels

pre-set width	tieback sizes	Small	Medium	Large
		5"W x 26"L	5"W x 33"L	5"W x 44"L
Small	50"W	x		
	75"W	x		
	100"W	x		
Medium	125"W		x	
	150"W		x	
Large	175"W			x
	200"W			x

SIZING SOLUTIONS

Grommet Panel Sizing Solutions - for pre-set widths

- Our recommendations allow for an approximate 2.25 : 1 fullness
- Bottom hem is 4"
- Side hems are 1.5"
- Grommets offered in 3 finishes. Size of outer diameter: 2.5", size of inner diameter: 1.5".
- Only rods and poles 1¼" diameter and less can be used to hang these grommet panels.
- Final length is from top inside diameter of grommet to bottom of panel.

Total Width to Cover:		Pre-Set Widths Available							
		50"W	75"W	100"W	125"W	150"W	175"W	200"W	
30"- 40"W	Use this # of Panels	2	or	1					
41"- 60"W		2		or	1				
61"- 80"W				2		or		1	
81"- 100"W		2							
101"- 120"W						2			
121"- 140"W		2							
141"- 160"W								2	

Contoured Tiebacks for Pre-Set Width Grommet Panels

pre-set width	tieback sizes	Small	Medium	Large
		5"W x 26"L	5"W x 33"L	5"W x 44"L
Small	50"W	x		
	75"W	x		
	100"W	x		
Medium	125"W		x	
	150"W		x	
Large	175"W			x
	200"W			x

Soft Wave Fold Drapery Track System Bracket Options

Note wall projection clearances on illustrations below:

Single ceiling-mounted bracket

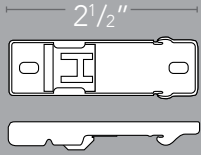

*use 2 for double track effect

Single wall-mounted bracket

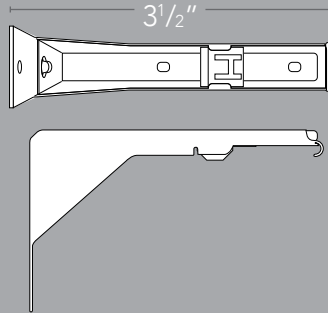

Double wall-mounted bracket

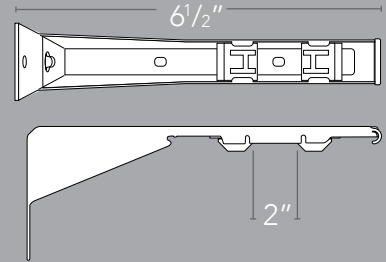

*distance between the two tracks is 2"

Attaching Drapery to Track System

- Metal post tape is attached to top of panels and snaps into carriers on the track.
- Metal post tape may be visible at top of drapery, particularly on sheers.
- Note: 1/4" light gap exists between top of drapery and track.

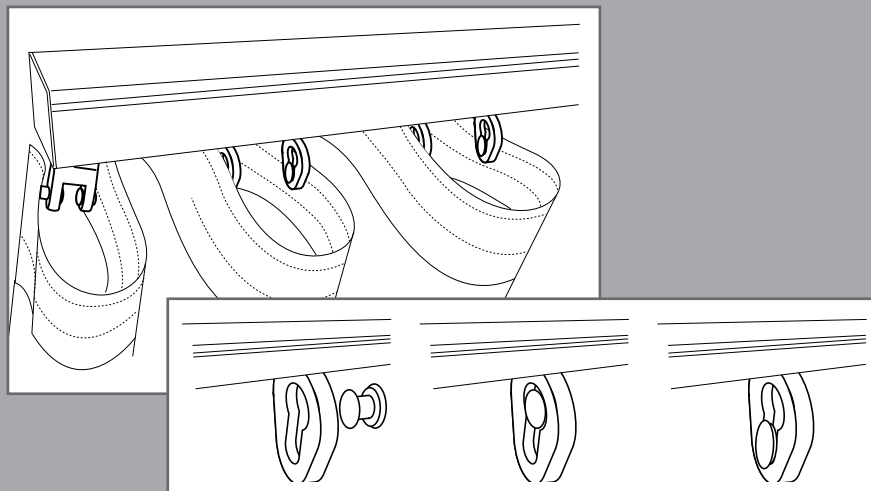

Unlined Precise Width Soft Wave Fold & Track System

Panel/Wand Length Info:

Standard Wand Length		Standard Wand Length	
Panel Length (inches)	Wand Length (inches)	Panel Length (inches)	Wand Length (inches)
12	10	90	42
13	11	91	43
14	12	92	44
15	13	93	45
16	14	94	46
17	15	95	47
18	16	96	48
19	17	97	49
20	18	98	50
21	19	99	51
22	20	100	52
23	21	101	53
24	22	102	54
25	23	103	55
26	24	104	56
27	25	105	57
28	26	106	58
29	27	107	59
30	28	108	60
31	29	109	61
32	30	110	62
33	31	111	63
34 - 80	32	112	64
81	33	113	65
82	34	114	66
83	35	115	67
84	36	116	68
85	37	117	69
86	38	118	70
87	39	119	71
88	40	120	72
89	41		



POLE MOUNTED VALANCES

Use a Pole Mounted Valance alone or layered over blinds, shades, and drapery. Decorative Pole Mounted Valances add interest and soften hard window coverings.

6" parisian pleated drapery panels: chenille damask, peacock
with tuxedo pleat valance: chenille damask, peacock

POLE MOUNTED VALANCE STYLES

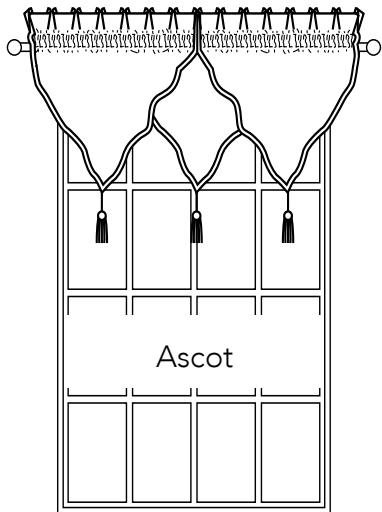

Ascot

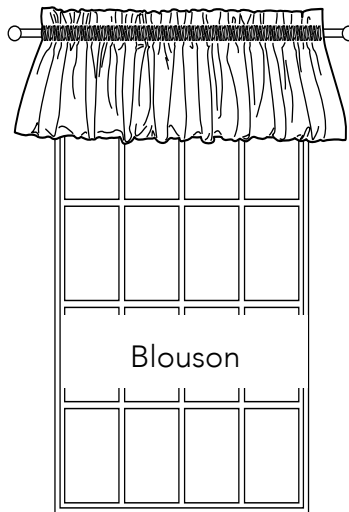

Blouson

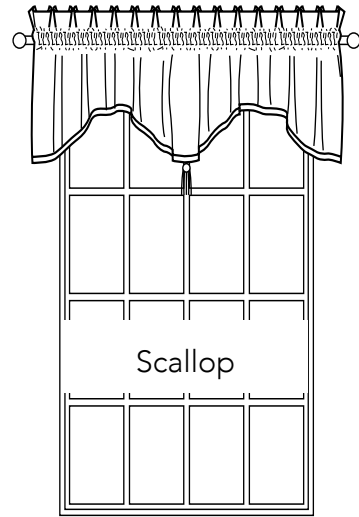

Scallop

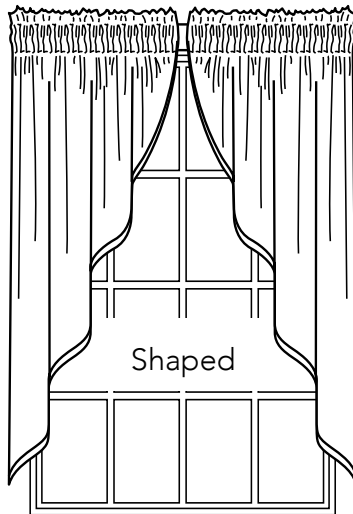

Shaped

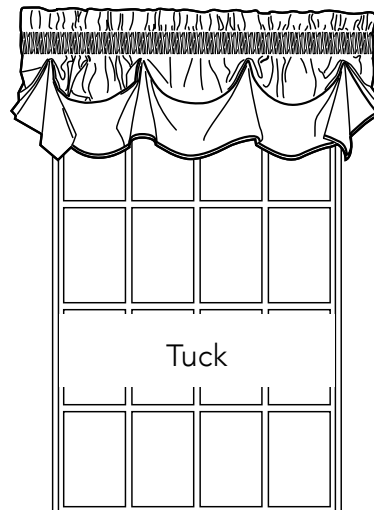

Tuck

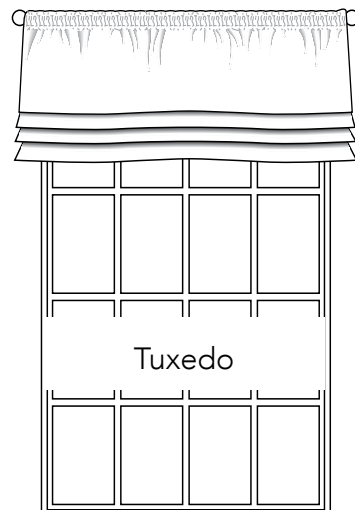

Tuxedo

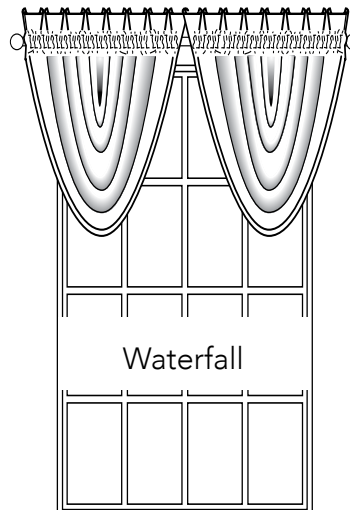

Waterfall

ASCOT VALANCE

- > 50"W x 21"L from bottom of rod pocket
- > Order 1 unit for every 20" of window width
- > Mix and match patterns or all solid
- > Rod Pocket & Header Options:
 - 1½" pocket / 1½" header - use ¾" max. diameter rod
 - 3" pocket / 3" header - use 1¼" max. diameter rod, or 2½" basic rod
 - Includes ½" self-bias tape and coordinating tassel
- > Unlined - upgrade to Standard, Thermal Sateen, Standard Blackout or Premium Blackout
- > Upgrade with cord or fringe on the bottom edge for a more custom look
(see p.79-81 for options)



ascot pole mounted valance:
charleston/bandana floral, blue

BLOUSON VALANCE

- > Available in precise widths to cover window widths from 12"W - 96"W
- > 15"L includes pocket
- > Order 1 unit for every 40" of window width
- > Tubular pocket can be stuffed with tissue for pouf effect or left flat for tailored effect
- > Rod Pocket & Header Options:
 - 1½" pocket / 1½" header - use ¾" max. diameter rod
 - 3" pocket / 3" header - use 1¼" max. diameter rod, or 2½" basic rod
- > Unlined - no lining upgrades
- > No tassel, cord or fringe upgrades



blouson pole mounted valance:
imari/flower power print, indigo

SHAPED VALANCE

- > Shaped Valances are sold as a pair
- > 104"W pair (52"W each) x 36"L, 63"L or 84"L
- > Pair with Ascots or Waterfall Valances or use alone
- > Rod Pocket & Header Options:
 - 1½" pocket / 1½" header - use ¾" max. diameter rod
 - 3" pocket / 3" header - use 1¼" max. diameter rod, or 2½" basic rod
 - Includes 1/2" self-bias tape and coordinating tassel
- > Standard self lining - no lining upgrades
- > Upgrade with cord or fringe on the bottom edge for a more custom look (see p.79-81 for options)



shaped pole mounted valance:
farrell print/country blossom, vintage gold

WATERFALL VALANCE

- > 68"W x 38"L
- > Shirrs to 23"W x 20"L on a decorative pole
- > Order 1 unit for every 23" of window width
- > Rod Pocket & Header Options:
 - 1½" pocket / 1½" header - use ¾" max. diameter rod
 - 3" pocket / 3" header - use 1¼" max. diameter rod, or 2½" basic rod
 - Includes ½" self-bias tape and coordinating tassel
- > Unlined - upgrade to Standard, Thermal Sateen, Standard Blackout or Premium Blackout
- > Upgrade with cord or fringe on the bottom edge for a more custom look
(see p.79-81 for options)



waterfall pole mounted valance:
farrell print/country blossom, vintage gold

SCALLOPED VALANCE

- > Available in precise widths to cover window widths from 12"W - 96"W
- > 18"L at longest point includes pocket
- > Rod Pocket & Header Options:
 - 1½" pocket / 1½" header - use ¾" max. diameter rod
 - 3" pocket / 3" header - use 1¼" max. diameter rod, or 2½" basic rod
 - Includes ½" self-bias tape and coordinating tassel
- > Unlined - upgrade to Standard, Thermal Sateen, Standard Blackout or Premium Blackout
- > Upgrade with cord or fringe on the bottom edge for a more custom look
(see p.79-81 for options)



scalloped pole mounted valance:
camelot/silkesse, antique

TUCK VALANCE

- > Available in precise widths to cover window widths from 12"W - 96"W
- > 14"L includes pocket
- > For best effect, use basic white valance rods for this style
- > Rod Pocket & Header Options:
 - 1½" pocket / 1½" header - use ¾" max. diameter rod
 - 3" pocket / 3" header - use 1¼" max. diameter rod, or 2½" basic rod
 - Includes ½" self-bias tape and coordinating tassel
- > Unlined - upgrade to Standard, Thermal Sateen, Standard Blackout or Premium Blackout
- > Upgrade with cord or fringe on the bottom edge for a more custom look (see p.79-81 for options)

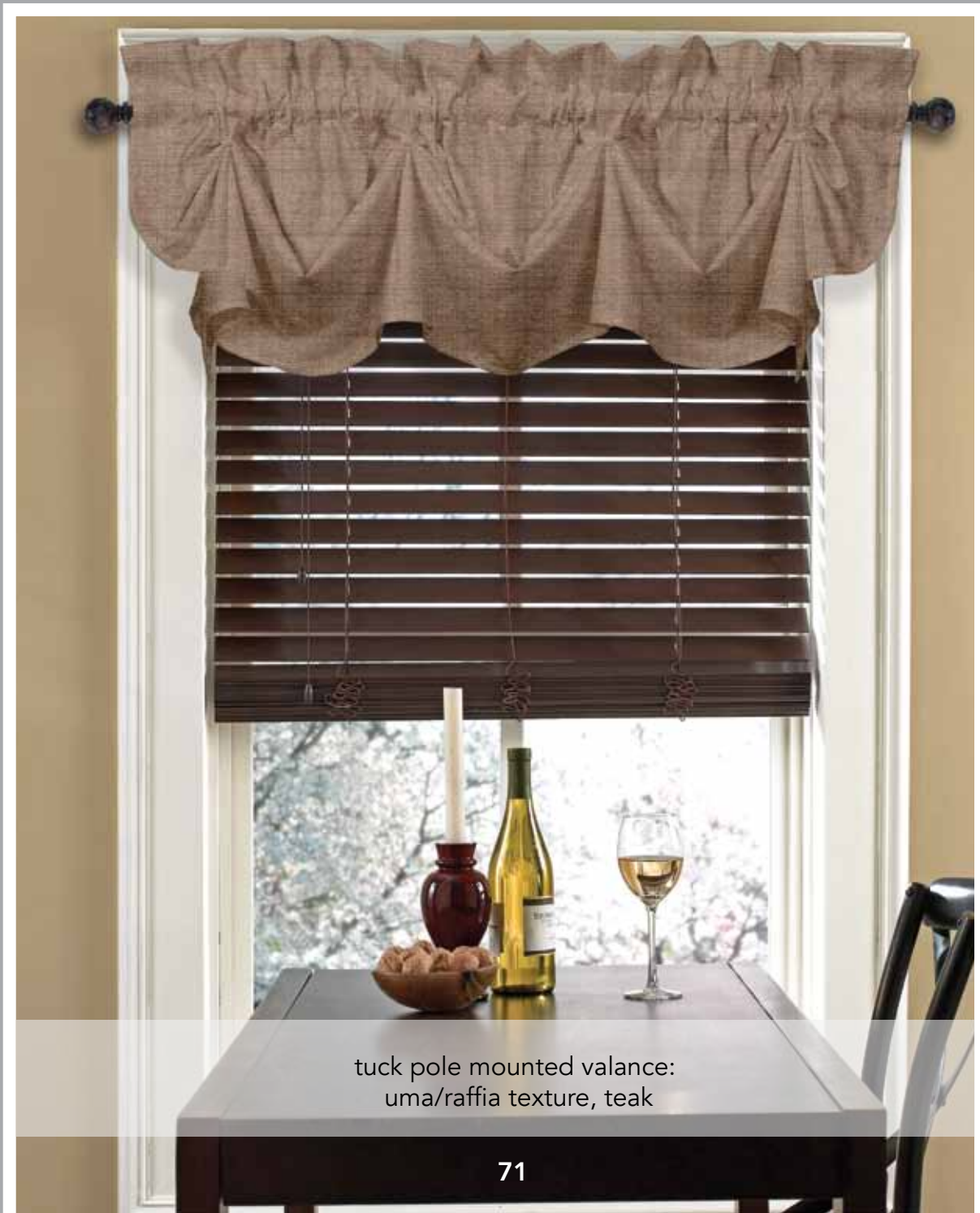

tuck pole mounted valance:
uma/raffia texture, teak

TUXEDO PLEAT VALANCE

- > Available in precise widths to cover window widths from 12"W - 96"W
- > 18"L includes 3" pocket
- > 3" pocket / no header - use 1 1/4" max. diameter rod, or 2 1/2" basic rod
- > Unlined - upgrade to Standard, Thermal Sateen, Standard Blackout or Premium Blackout
- > No decorative trim upgrades available



tuxedo pleat pole mounted valance:
chenille damask, peacock

A window is dressed with a board-mounted valance featuring a repeating geometric pattern. Below the valance are Roman shades with a damask pattern. The window is flanked by dark curtains. In the foreground, a dining table with a dark wood top and a patterned backrest is visible, along with a white upholstered chair with dark wood framing. A vase of white lilies sits on the table. The background shows a city skyline through the window.

BOARD MOUNTED VALANCES

Soften and frame windows with these classic valance treatments. These pre-fabricated constructions are simple to install. Use over other treatments for a layered look.

outer grommet drapery panels: donetta/ironwork print, licorice
inner grommet drapery panels: wilmington/cotton duck, ebony
front slats roman shades: essence/damask, onyx
with euro relaxed board mounted valance: donetta/ironwork print, licorice

BOARD MOUNTED VALANCE STYLES

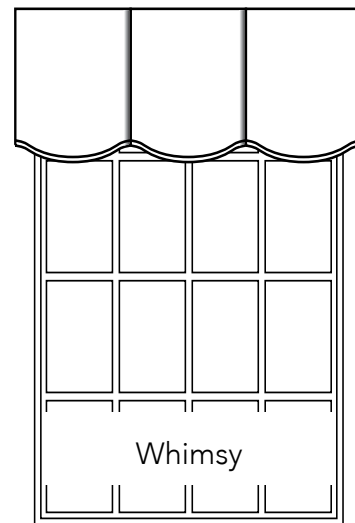
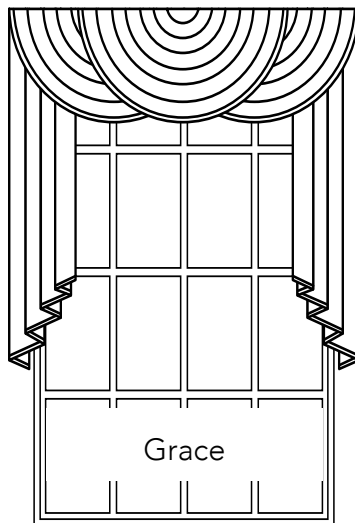
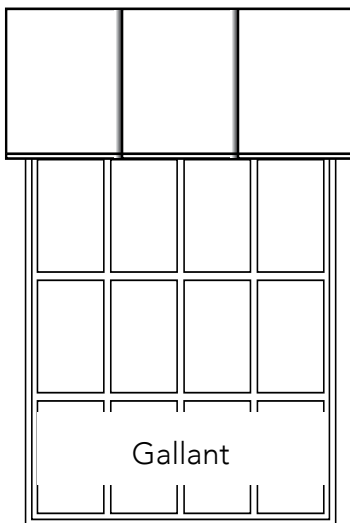
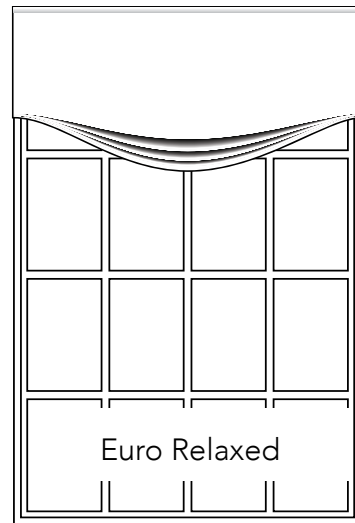
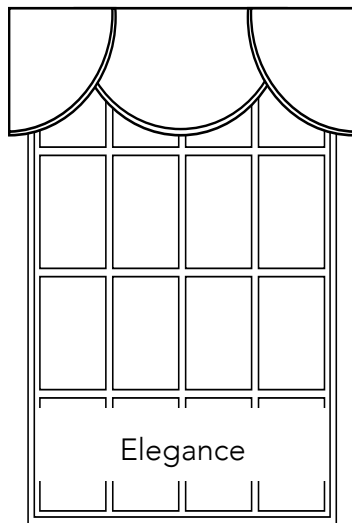
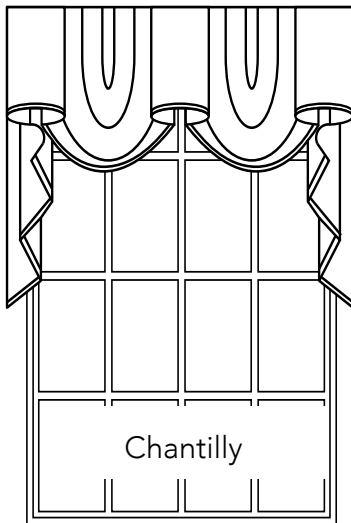

EURO RELAXED

- > Two returns available: 4" or 7"
 - 4" return is recommended for mounting over blinds and shades
 - 7" return is recommended for mounting over drapery treatments
- > Entire valance is lined with Standard lining
- > Standard with self tape on edge
- > No tassel, cord or fringe upgrades

scoops chart				
width	30"-60"	from 60 ¹ / ₂ " to 90"	from 90 ¹ / ₂ " to 120"	from 120 ¹ / ₂ " to 144"
# of scoops	1	2	3	4

minimum & maximum widths & lengths		
	minimum	maximum
width	30"W	*144"W
side length	14"L	
scoop drops to:	20"	

*made to the exact 1/2"

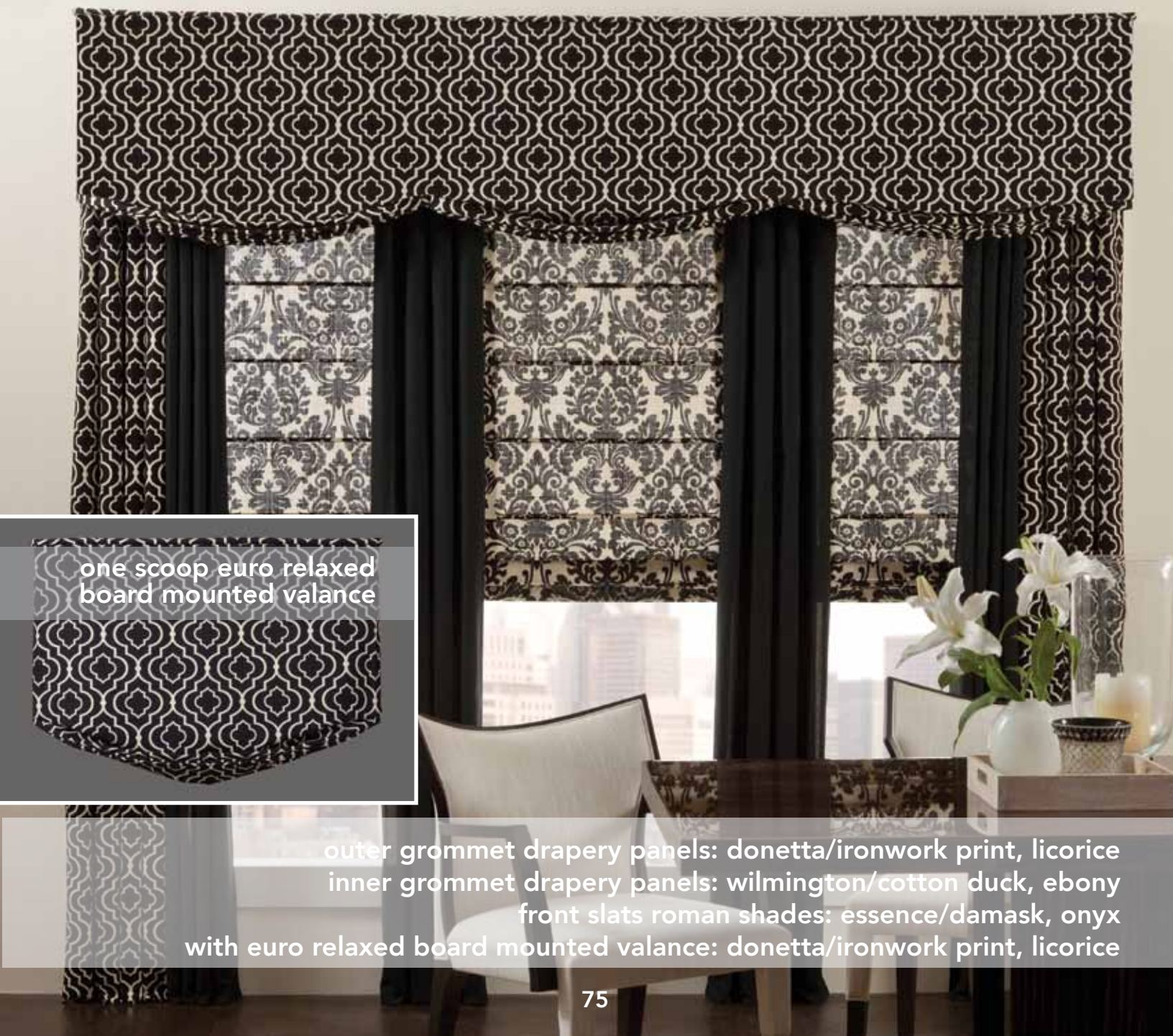

one scoop euro relaxed board mounted valance

outer grommet drapery panels: donetta/ironwork print, licorice
 inner grommet drapery panels: wilmington/cotton duck, ebony
 front slats roman shades: essence/damask, onyx
 with euro relaxed board mounted valance: donetta/ironwork print, licorice

WHIMSY

GALLANT

- > Pleat width will vary
- > Entire valance is lined with Standard lining
- > Standard with 1/2" self cord on top edge
- > Includes 1/2" self bias tape along bottom edge
- > Two returns available: 4" or 7"
 - 4" return is recommended for mounting over blinds and shades
 - 7" return is recommended for mounting over drapery treatments
- > Upgrade with cord or fringe on the bottom edge for a more custom look (see p.79-81 for options)

pleat chart					
width	up to 42"	from 42 ¹ / ₈ " to 66"	from 66 ¹ / ₈ " to 102"	from 102 ¹ / ₈ " to 126"	from 126 ¹ / ₈ " to 144"
# of scoops	3	4	7	9	10
maximum section width	14"	16 ¹ / ₂ "	14 ¹ / ₂ "	14"	14 ¹ / ₂ "

minimum & maximum widths & lengths		
	minimum	maximum
width	24"W	*144"W
length	18"L	

*made to the exact 1/2"



whimsy board mounted valance:
st. moritz/stainlgass floral, mineral



gallant board mounted valance:
st. moritz/stainlgass floral, caribbean

ELEGANCE

- > Entire valance is lined with Standard lining
- > Standard with 1/2" self cord on top edge
- > Includes 1/2" self bias tape along bottom edge
- > Two returns available: 4" or 7"
 - 4" return is recommended for mounting over blinds and shades
 - 7" return is recommended for mounting over drapery treatments
- > Upgrade with cord or fringe on the bottom edge for a more custom look (see p. 79-81 for options)

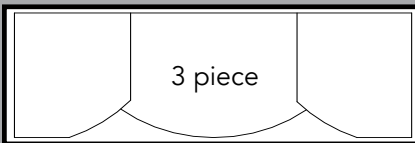
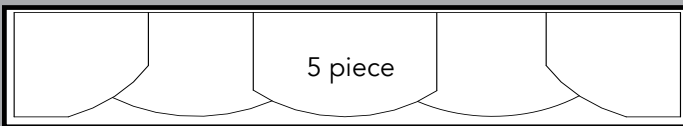
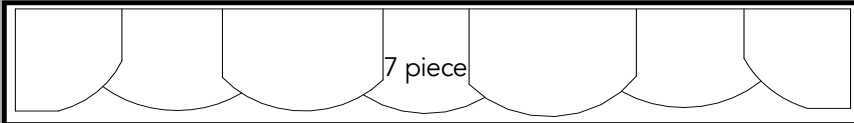

swag chart			
width	up to 63"	from 60 ¹ / ₂ " to 90"	from 90 ¹ / ₂ " to 120"
# of pieces	3	5	7

minimum & maximum widths & lengths	
minimum	
width	48"W
swag drops to:	18"

*made to the exact 1/2"



elegance board mounted valance:
 neptune/poly brocade, ebony with black/camel fringe
 soft fold roman shade: camelot/silkesse, antique

GRACE

- > Style is assembled with a central front swag with additional swags spread out on both sides behind the central swag
- > Cascades are mounted under the swags
- > Swags are lined with Standard lining
- > Cascades are self-lined
- > Choose 36", 63", 84", 96", 108" L
- > Standard with 1/2" self cord on top edge
- > Swags and Cascades include 1/2" self bias tape edge
- > Two returns available: 4" or 7"
 - 4" return is recommended for mounting over blinds and shades
 - 7" return is recommended for mounting over drapery treatments
- > Upgrade with cord or fringe on the bottom edge for a more custom look (see p.79-81 for options)

swag chart					
width	up to 44"	from 44½" to 66"	from 66½" to 90"	from 90½" to 138"	from 138½" to 180"
# of pieces	1	2	3	5	7

minimum & maximum widths & lengths	
minimum	
width	30"W
swag drop:	choose 18" or 22"

*made to the exact 1/2"



grace board mounted valance: lexi/drapeable flannel, sky

CHANTILLY

- > Swags are lined with Standard lining
- > Cascades are self-lined
- > Standard with 1/2" self cord on top edge
- > Trimmed with 1/2" self bias tape edge
- > Two returns available: 4" or 7"
 - 4" return is recommended for mounting over blinds and shades
 - 7" return is recommended for mounting over drapery treatments
- > Upgrade with cord or fringe on the bottom edge for a more custom look (see p.79-81 for options)

pleat chart					
width	up to 50"	from 50 1/2" to 74"	from 74 1/2" to 98"	from 98 1/2" to 122"	from 122 1/2" to 146"
# of swags	2	3	4	5	6
# of jabots	3	4	5	6	7

minimum & maximum widths & lengths	
minimum	
width	36"W
swag drop:	18"L
jabot drop:	12"L
cascades drop:	36"L

*made to the exact 1/2"



chantilly board mounted valance: meta/cabana stripe, peacock with chocolate/spa fringe



UPHOLSTERED CORNICE BOARDS

Soften and frame windows with these classic valance treatments. These pre-fabricated constructions are simple to install. Use over other treatments for a layered look.

modern upholstered cornice board: camelot/silkesse, antique

UPHOLSTERED CORNICE BOARD STYLES

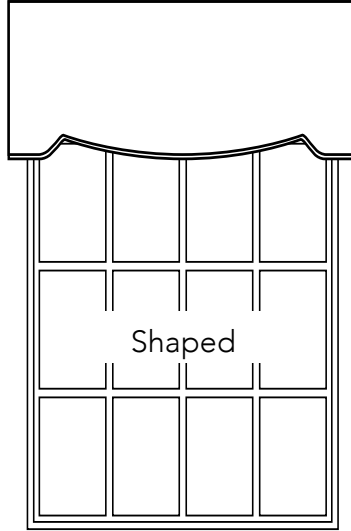
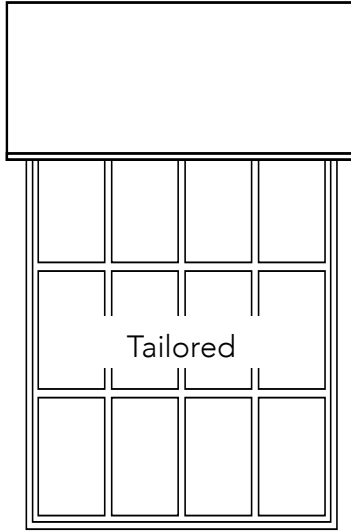
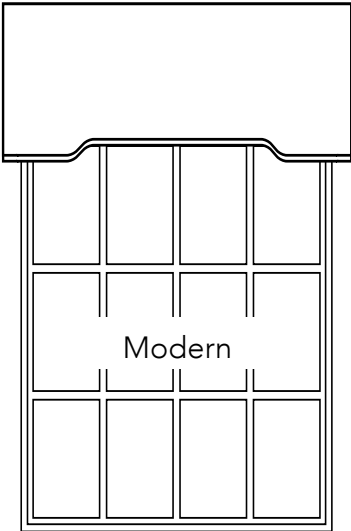
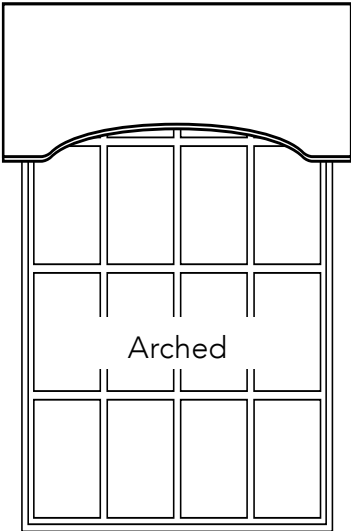

ARCHED MODERN

- > Upholstery fiber fill and decorative fabric are supported by an all wood frame
- > Matching dust cap cover is always included
- > Lines of cornice shape will elongate with wider widths
- > Drop length: choose 12" or 16"
- > Minimum width: 24"
- > Includes 1/2" self cording along bottom edge
- > Must add a minimum of + 2" to your window frame width when ordering (made to the exact 1/2")
- > Two returns available: 4" or 7"
 - 4" return is recommended for mounting over blinds and shades
 - 7" return is recommended for mounting over drapery treatments
- > Upgrade with cord or fringe on the bottom edge for a more custom look (see p.79-81 for options)
- > 52"W and above will have vertical seams. Fabric will not be railroaded; it is only made up the roll.
- > Upholstered Cornice Boards 72"W and above will be hinged.



arched cornice board:
neptune/poly brocade, sage



modern cornice board:
camelot/silkese, antique
plain classic pleated roman shade:
lexi/drapeable flannel, chino

TAILORED SHAPED

- > Upholstery fiber fill and decorative fabric are supported by an all wood frame
- > Matching dust cap cover is always included
- > Lines of cornice shape will elongate with wider widths
- > Drop length: choose 12" or 16"
- > Minimum width: 24"
- > Includes 1/2" self cording along bottom edge
- > Must add a minimum of + 2" to your window frame width when ordering (made to the exact 1/2")
- > Two returns available: 4" or 7"
 - 4" return is recommended for mounting over blinds and shades
 - 7" return is recommended for mounting over drapery treatments
- > Upgrade with cord or fringe on the bottom edge for a more custom look (see p.79-81 for options)
- > 52"W and above will have vertical seams. Fabric will not be railroaded; it is only made up the roll.
- > Upholstered Cornice Boards 72"W and above will be hinged.



tailored cornice board:
ashton stripe/poly awning stripe, camel



shaped cornice board:
ikat ombre horizontal stripe, coconut
plain classic pleated roman shade:
lexi/drapeable flannel, chino

1 1/4" METAL DECORATIVE WINDOW HARDWARE

• 3 Rod Set Sizes • 7 Finial Styles • 3 Finishes



Dover finials

metal finials (2)

length	3 1/8"
diameter/width	2 1/8"
packaged	pair
stock#	MDFo000



Georgian finials

metal finials (2)

length	3 1/8"
diameter/width	2 1/8"
packaged	pair
stock#	MGFo000



Ball finials

metal finials (2)

length	3 1/8"
diameter/width	2 1/8"
packaged	pair
stock#	MBFo000



Hampton finials

metal finials (2)

Length	3 5/8"
diameter/width	2"
packaged	pair
stock#	MHFo000



Pearl finials

poly resin finials (2)

length	3 1/8"
diameter/width	2 1/8"
packaged	pair
stock#	MPFo000



Scroll finials

metal finials (2)

length	3"
diameter/width	2 1/8"
packaged	pair
stock#	MCFo000



Square finials

metal finials (2)

length	3 1/8"
diameter/width	2 1/8"
packaged	pair
stock#	MQFo000

End Caps for Under Rods

packaged	pair
stock#	MECo000

40" Extension Rod & One Standard Bracket

packaged	1 each
stock#	MERo000



End Cap

5" Extension Bracket

ext. to back of front rod	5"
packaged	1 each
stock#	MEBo000



Double Bracket

Double Bracket

ext. to back of front rod	5"
to back of rear rod	2 1/2"
packaged	1 each
stock#	MDBo000

Rings with Clips

packaged	7 each
length	2 1/4"
stock#	MCRo000

Note:

Eyelet + clip adds 3" of length (so deduct 3" from the panel length)

Eyelet only adds 2" of length (so deduct 2" from the panel length)



Clip Rings

C-Rings Kit

packaged	14 each + bracket
length	2 3/4"
stock#	MPM10000
order 1 kit for every 48" of rod width you plan to cover	



C-Rings

1 1/4" Rod Set sizes

length	# of brackets	stock#
28" - 48"	2	MRS2848
48" - 86"	3	MRS4886
86" - 120"	4	MRS86120

Projection is 3" to the back of the rod & 4 1/2" to the front of the rod

antique brass
color# 14

satin nickel
color# 78

oil rubbed
bronze
color# 95



CORD • FRINGE • TASSELS



TRIMS AVAILABLE: • 3/8" decorative cord • 2 1/2" loop fringe • 3" tassel

Suggested Trim Colors

Fabric Name	Color	Trim & Cord Colors	Price Group
Amagansett - Mod Floral	Sorbet	Spa Blue	B
Amagansett - Mod Floral	Sterling	Charcoal/Silver	B
Ashton Stripe - Poly Awning Stripe	Beige	Linen	A
Ashton Stripe - Poly Awning Stripe	Camel	Jungle	A
Ashton Stripe - Poly Awning Stripe	Chocolate	Black/Camel, Chocolate/Spa	A
Ashton Stripe - Poly Awning Stripe	Greysmoke	Charcoal/Silver	A
Ashton Stripe - Poly Awning Stripe	Ivory	Linen, Spa Blue	A
Ashton Stripe - Poly Awning Stripe	Linen	Spa Blue, Jungle	A
Ashton Stripe - Poly Awning Stripe	Navy	Navy/Gold	A
Ashton Stripe - Poly Awning Stripe	Nugget	Soft Gold	A
Ashton Stripe - Poly Awning Stripe	Wine	Wine/Gold	A
Bermuda - Plisse Scroll	Beige	Soft Gold	B
Bermuda - Plisse Scroll	Mushroom	Spa Blue	B
Bermuda - Plisse Scroll	Sage	Spa Blue	B
Bermuda - Plisse Scroll	White	Black/Natural	B
Camelot - Silkesse	Antique	Soft Gold	A
Camelot - Silkesse	Mist	Spa Blue	A
Camelot - Silkesse	Oxford	Charcoal/Silver	A
Camelot - Silkesse	Patina	Jungle	A
Camelot - Silkesse	Pearl	Linen	A
Camelot - Silkesse	Pomegranate	Rust Multi	A
Camelot - Silkesse	Powder	Linen	A
Camelot - Silkesse	Sangria	Wine/Gold	A
Camelot - Silkesse	Shadow	Charcoal/Silver	A
Camelot - Silkesse	Tussah	Soft Gold	A
Camelot - Silkesse	Walnut	Black/Camel	A
Camelot - Silkesse	Wheat	Spa Blue	A
Captiva - Sandrift Texture	Amber	Soft Gold	B
Captiva - Sandrift Texture	Bone	Spa Blue	B
Captiva - Sandrift Texture	Brie	Linen	B
Captiva - Sandrift Texture	Drizzle	Charcoal/Silver	B
Captiva - Sandrift Texture	Earth	Jungle	B
Captiva - Sandrift Texture	Sandlewood	Soft Gold	B
Captiva - Sandrift Texture	Seaport	Navy/Gold	B
Captiva - Sandrift Texture	Terracotta	Rust Multi	B
Charleston - Bandana Floral	Blue	Cobalt/Natural	B
Charleston - Bandana Floral	Gold	Soft Gold	B
Charleston - Bandana Floral	Slate	Black/Natural	B
Chenille Damask	Cinnabar	Wine/Gold	C
Chenille Damask	Peacock	N/A	C
Chenille Damask	Pewter	Charcoal/Silver	C
Donetta - Ironwork Print	Barley	Soft Gold	C
Donetta - Ironwork Print	Cascade	Spa Blue	C
Donetta - Ironwork Print	Licorice	Black/Natural	C
Essence - Damask	Onyx	Black/Natural	C
Essence - Damask	Smoke	N/A	C
Farrell Print - Country Blossom	Crimson	Rust Multi	A
Farrell Print - Country Blossom	Vintage Gold	Soft Gold	A
Fergus - Linen Stripe	Spring	Jungle	D
Fergus - Linen Stripe	Stream	Spa Blue	D
Findlay - All Over Willow	Charcoal	Black/Natural	C
Findlay - All Over Willow	Saddle	Soft Gold, Black/Camel	C
Findlay - All Over Willow	Seaglass	Spa Blue	C

Fabric Name	Color	Trim & Cord Colors	Price Group
Findlay - All Over Willow	Shadow	Black/Camel	C
Full Circle- Circle Matelasse	Anchor	Black/Natural	C
Full Circle- Circle Matelasse	Rope	Spa Blue	C
Full Circle- Circle Matelasse	Sail	Black/Natural	C
Full Circle- Circle Matelasse	Sterling	Black/Natural	C
Genova - Ogee Embroidery	Beach	Jungle	D
Genova - Ogee Embroidery	Mineral	Spa Blue	D
Gent - Linen Blend Solid	Bisque	Black/Natural	C
Gent - Linen Blend Solid	Flax	Spa Blue	C
Gent - Linen Blend Solid	Ivory	Spa Blue	C
Gent - Linen Blend Solid	Mushroom	Spa Blue	C
Gent - Linen Blend Solid	Smoke	Jungle	C
Gent - Linen Blend Solid	Vanilla	Black/Natural	C
Harrison Stripe - Relax Stripe	Graphite	Charcoal/Silver	B
Harrison Stripe - Relax Stripe	Vintage Red	Rust Multi	B
Helmsley - Lattice Embroidery	Glow	Soft Gold	B
Helmsley - Lattice Embroidery	Pearl	Linen	B
Helmsley - Lattice Embroidery	Stone	Spa Blue	B
Herringbone - Herringbone Twill	Camel	Linen, Soft Gold	A
Herringbone - Herringbone Twill	Chocolate	Black/Camel, Choc./Spa	A
Herringbone - Herringbone Twill	Cream	Linen, Spa Blue	A
Herringbone - Herringbone Twill	Grey	Charcoal/Silver	A
Ikat Ombre Horizontal Stipe	Coconut	Jungle	B
Ikat Ombre Horizontal Stipe	Tiki	Black/Camel, Soft Gold	B
Imari - Flower Power Print	Green Tea	N/A	B
Imari - Flower Power Print	Indigo	Cobalt/Natural	B
Kitani - Y Print	Green Tea	N/A	B
Kitani - Y Print	Indigo	Cobalt/Natural	B
Lexi - Drapeable Flannel	Cafe	Jungle	B
Lexi - Drapeable Flannel	Chino	Chocolate/Spa	B
Lexi - Drapeable Flannel	Cream	Spa Blue, Soft Gold	B
Lexi - Drapeable Flannel	Grey	Charcoal/Silver	B
Lexi - Drapeable Flannel	Sky	Spa Blue, Choc./Spa	B
Lexi - Drapeable Flannel	White	Black/Natural	B
Lucky - Cotton Sateen	Black	Black/Natural	A
Lucky - Cotton Sateen	Caramel	Black/Camel	A
Lucky - Cotton Sateen	Lacquer	Wine/Gold	A
Lucky - Cotton Sateen	Marble	Spa Blue	A
Lucky - Cotton Sateen	Natural	Spa Blue	A
Lucky - Cotton Sateen	Navy	Navy/Gold	A
Lucky - Cotton Sateen	Parchment	Soft Gold	A
Lucky - Cotton Sateen	Putty	Jungle	A
Lucky - Cotton Sateen	Silver	Black/Natural	A
Lucky - Cotton Sateen	Sprout	N/A	A
Lucky - Cotton Sateen	Teal	N/A	A
Lucky - Cotton Sateen	White	Black/Natural	A
Lyon - Floating Vine	Black	Black/Camel	A
Lyon - Floating Vine	Golden	Soft Gold, Black/Camel	A
Lyon - Floating Vine	Ivory	Spa Blue	A
Lyon - Floating Vine	Lt. Blue	Spa Blue, Choc./Spa	A
Lyon - Floating Vine	Wine	Plum/Sage	A
Madison - Cotton Candlewicking	Cashmere	Jungle	A
Madison - Cotton Candlewicking	Cotton	Spa Blue	A

Suggested Trim Colors

Fabric Name	Color	Trim & Cord Colors	Price Group
Madison - Cotton Candlewicking	Linen	Spa Blue	A
Matrix - Plush Trellis	Chestnut	Black/Camel	C
Matrix - Plush Trellis	Dove Grey	Black/Natural	C
Matrix - Plush Trellis	Golden Berry	Rust Multi	C
Matrix - Plush Trellis	Robins Egg	Chocolate/Spa	C
Melodie - Toile Paisley	Frost Blue	Cobalt/Natural	C
Melodie - Toile Paisley	Platinum Grey	Black/Natural	C
Meta - Cabana Stripe	Coffee	Black/Camel	B
Meta - Cabana Stripe	Crimson	Rust Multi	B
Meta - Cabana Stripe	Peacock	Chocolate/Spa	B
Meta - Cabana Stripe	Spa	Spa Blue	B
Moorea - Flock Leaf	Gold	Rust Multi	B
Moorea - Flock Leaf	Pottery	Black/Camel	B
Moorea - Flock Leaf	Spa	Spa Blue	B
Moorea - Flock Leaf	Zebra	Black/Natural	B
Neptune - Poly Brocade	Brick	Rust Multi	B
Neptune - Poly Brocade	Ebony	Black/Camel	B
Neptune - Poly Brocade	Sage	Jungle	B
Orlando - Braid Jacquard	Champagne	Linen	C
Orlando - Braid Jacquard	Charcoal	Charcoal/Silver	C
Orlando - Braid Jacquard	Cream	Spa Blue	C
Parma - Paisley Embroidery	Bamboo	Jungle	D
Parma - Paisley Embroidery	Pearl	Linen, Spa Blue	D
Parma - Paisley Embroidery	Platinum	Charcoal/Silver	D
Polaris - Asymmetrical Stripe	Azure	Charc./Silver, Navy/Gold	B
Polaris - Asymmetrical Stripe	Crimson	Wine/Gold	B
Polaris - Asymmetrical Stripe	Linen	Plum/Sage	B
Polaris - Asymmetrical Stripe	Mushroom	Spa Blue, Jungle	B
Polaris - Asymmetrical Stripe	Saddle	Soft Gold, Black/Camel	B
Polaris - Asymmetrical Stripe	Snow	Linen/Spa Blue	B
Raw Silk Crepe	Oyster	Spa Blue, Choc./Spa	B
Raw Silk Crepe	Pebble	Black/Camel, Jungle	B
Raw Silk Crepe	Sand	Spa Blue, Jungle	B
Raw Silk Crepe	Water	Spa Blue, Choc./Spa	B
Regal Square - Square Dot	Moonlight	Black/Natural	B
Regal Square - Square Dot	Mustard	Black/Camel, Soft Gold	B
Regal Square - Square Dot	Parchment	Linen, Spa Blue	B
Regal Square - Square Dot	Spa	Spa Blue	B
Regal Square - Square Dot	Winter White	Black/Natural	B
Rio - Faux Linen	Atlantic	Navy/Gold	A
Rio - Faux Linen	Camel	Soft Gold	A
Rio - Faux Linen	Cream	Linen	A
Rio - Faux Linen	Lime	N/A	A
Rio - Faux Linen	Putty	Soft Gold	A
Rio - Faux Linen	Rye	Soft Gold	A
Rio - Faux Linen	Stone	Charcoal/Silver	A
Rio - Faux Linen	Tobacco	Black/Camel	A
Rio - Faux Linen	Winter White	Linen	A
Silk Road - Reeded Silk Stripe	Pearl	Spa Blue	A
Silk Road - Reeded Silk Stripe	Sage	Jungle	A
Silk Road - Reeded Silk Stripe	Silver	Charcoal/Silver	A
Silk Road - Reeded Silk Stripe	White	Black/Natural	A
Silkara - Shimmery Crosshatch Texture	Cashew	Linen	B
Silkara - Shimmery Crosshatch Texture	Earth	Jungle	B

Fabric Name	Color	Trim & Cord Colors	Price Group
Silkara - Shimmery Crosshatch Texture	Harvest	Rust/Multi	B
Silkara - Shimmery Crosshatch Texture	Marble	Linen, Spa Blue	B
Silkara - Shimmery Crosshatch Texture	Myrtle	Chocolate/Spa	B
Silkara - Shimmery Crosshatch Texture	Sterling	Charcoal/Silver	B
Species - animal jacquard	Linen	Linen	C
Species - animal jacquard	Safari	Black/Camel	C
Species - animal jacquard	Truffle	Chocolate/Spa	C
Species - animal jacquard	Zinc	Spa Blue	C
Sri Lanka - Tribal Print	Driftwood	Jungle	A
Sri Lanka - Tribal Print	Harvest	Wine/Gold	A
St. Moritz - Stainglass Floral	Caribbean	Navy/Gold	B
St. Moritz - Stainglass Floral	Mineral	Soft Gold	B
St. Moritz - Stainglass Floral	Tribal Red	Black/Natural	B
Troika - Formal Cabana Stripe	Champagne	Soft Gold	C
Troika - Formal Cabana Stripe	Cocoa	Black/Camel, Soft Gold	C
Troika - Formal Cabana Stripe	Hemp	Jungle	C
Tullahoma - Ikat Print	Bay Blue	Cobalt/Natural	A
Tullahoma - Ikat Print	Charcoal Ink	Black/Natural	A
Tullahoma - Ikat Print	Marble Grey	Black/Natural	A
Tullahoma - Ikat Print	Sand Dollar Tan	Spa Blue	A
Tulsa - Matka Silk	Ash	Black/Natural	B
Tulsa - Matka Silk	Claret	Wine/Gold	B
Tulsa - Matka Silk	Linen	Spa Blue	B
Tulsa - Matka Silk	Mushroom	Jungle	B
Tulsa - Matka Silk	Oyster	Spa Blue	B
Tulsa - Matka Silk	Pewter	Charcoal/Silver	B
Tulsa - Matka Silk	Sage	Spa Blue	B
Tulsa - Matka Silk	Tan	Soft Gold	B
Tulsa - Matka Silk	White	Black/Natural	B
Uma - Raffia Texture	Bone	Spa Blue	B
Uma - Raffia Texture	Graphite	Black/Natural	B
Uma - Raffia Texture	Off-White	Black/Natural	B
Uma - Raffia Texture	Sand	Linen	B
Uma - Raffia Texture	Teak	Jungle	B
Uma - Raffia Texture	Wheat	Soft Gold	B
Valdosta - Jacobean Print	Blackbird	Black/Camel	C
Valdosta - Jacobean Print	Driftwood	Jungle	C
Waterloo - Ditzzy Dot	Black	Black/Camel	B
Waterloo - Ditzzy Dot	Brick	Rust Multi	B
Waterloo - Ditzzy Dot	Natural	Linen	B
Waterloo - Ditzzy Dot	Olive	Jungle	B
Waterloo - Ditzzy Dot	Pewter	Charcoal/Silver	B
Waterloo - Ditzzy Dot	Sand	Soft Gold	B
Wilmington - Cotton Duck	Bramble	Linen	A
Wilmington - Cotton Duck	Buff	Linen	A
Wilmington - Cotton Duck	Calente	Wine/Gold	A
Wilmington - Cotton Duck	Ebony	Black/Camel, Black/ Natural	A
Wilmington - Cotton Duck	Moonlight	Black/Natural	A
Wilmington - Cotton Duck	Natural	Linen	A
Wilmington - Cotton Duck	Nautical	Navy/Gold	A
Wilmington - Cotton Duck	Nugget	Soft Gold, Black/Camel, Wine/Gold	A
Wilmington - Cotton Duck	Pewter	Charcoal/Silver	A
Wilmington - Cotton Duck	Water	Spa Blue	A
Wilmington - Cotton Duck	White	Linen	A

