

# Banded Fabric Loop Roller Shade with Radio Control Motor and Controls

## INSTALLATION INSTRUCTIONS

**Install the Shade Before Attempting to Operate The Motor.**

**Step 1. Check Package Contents**  
Missing part? Call 800-264-1190

Mounting hardware kit includes the following:

Part	Quantity
a. Mounting Brackets	2 for shades up to 45" wide 3 for shades up to 72" wide
b. Extension Brackets (for outside mounts)	2 for shades up to 45" wide 3 for shades up to 72" wide
c. Screws	4 for shades up to 45" wide 6 for shades up to 72" wide
d. Wall Anchors	4 for shades up to 45" wide 6 for shades up to 72" wide

### Step 2. Tools required

Pencil, tape measure, level, screw driver, pliers, step stool, drill.

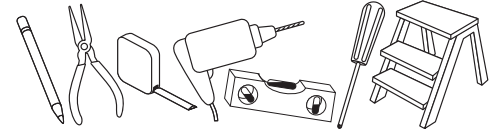

### Step 3. Installation

Your blind may be installed either inside the window frame or outside the window frame.

**Wallboard or Plaster:** use wall anchors.

**Concrete, Stone, Brick:** use a masonry drill bit and anchors or screws specifically designed for masonry (not included).

#### Inside Mounting:

One bracket should be positioned about 2" to 6" from each end of the head rail. For wider shades that require 3 or 4 brackets, these should be spaced evenly between the two outermost brackets.

Attach each bracket to the inner top of the window opening using the screws provided. Pre-drill the screw holes using a 5/64" drill bit. The extension brackets are not used for inside mounts.

For flush inside mounts, attach the brackets to the head rail first (see drawings and attachment instructions below), and then position the shade in the window opening as desired. Then make pencil marks at the back of each bracket. Remove the brackets by pressing on the plastic tab. Align the brackets with the pencil marks, and then screw them in place as described above.

#### Outside Mounting:

Attach the Extension Brackets to the wall or window framing. One bracket should be positioned about 2" to 6" from each end of the head rail. For wider shades that require 3 or 4 brackets, these should be spaced evenly between the two outermost brackets. Pre-drill the screw holes using a 5/64" drill bit.

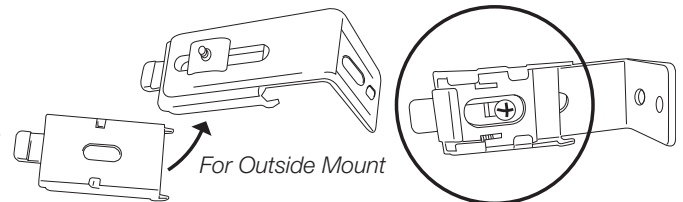

The brackets must be level – use a Spirit Level if necessary to assure proper alignment.

Then attach a Mounting Bracket to each Extension Bracket using the nut and bolt pre-attached to each Extension Bracket.

To adjust head rail extension, remove the shade from the mounting brackets by pressing on the plastic tabs at the front of each bracket. Then loosen the nut and bolt, and move the mounting brackets forward or backward as preferred.

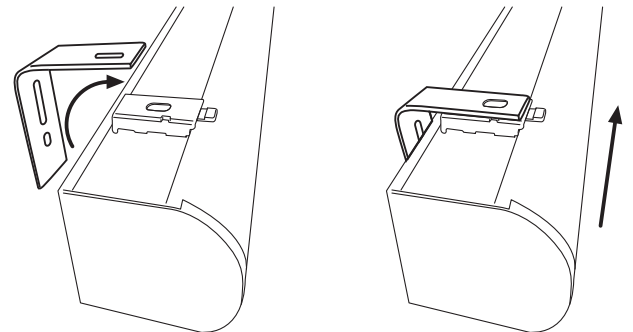

### Step 4. Securing the Head Rail

Slide the inner rear of the head rail onto the metal tabs at the back of each bracket, and then push up so that the brackets snap onto the head rail.

### IMPORTANT FINAL STEP TO PROPERLY SECURE BRACKETS:

pull the plastic tab on the front of each bracket outward toward the front of the shade to lock the brackets in place. For inside-mounts use pliers to grasp the tabs. Check carefully to assure that each bracket is properly secured

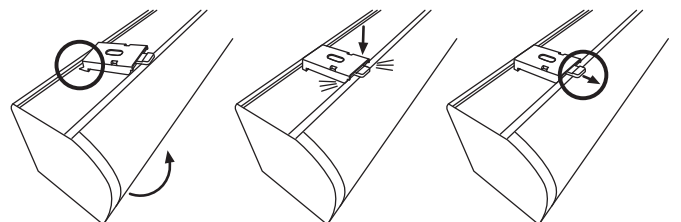

## Remote Transmitters

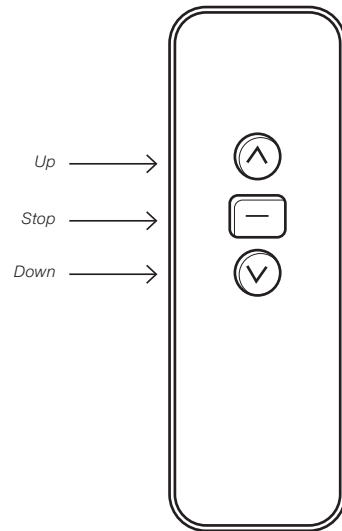

**Single Channel  
Remote Control Transmitter**

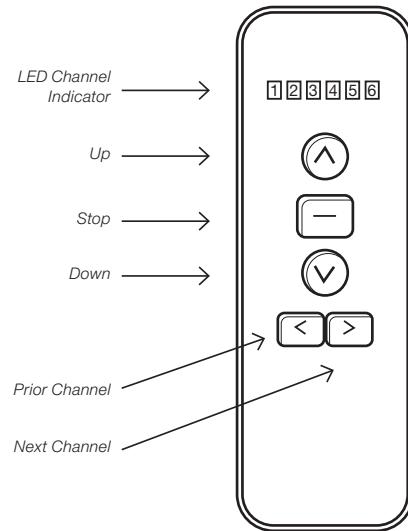

**Six (6) Channel  
Remote Control Transmitter**

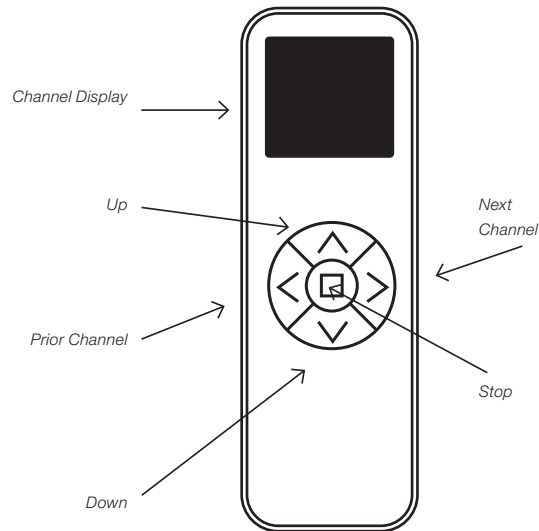

**Sixteen (16) Channel  
Remote Control Transmitter**

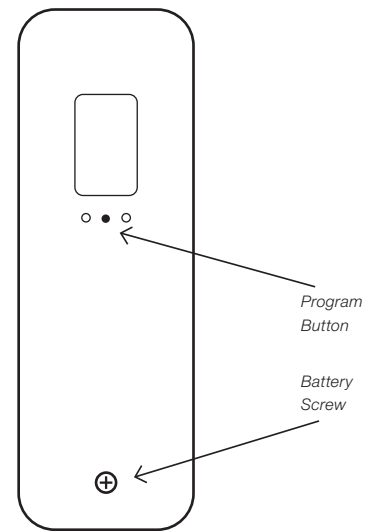

**Back of Remote Control  
Transmitter**

## Motor Head

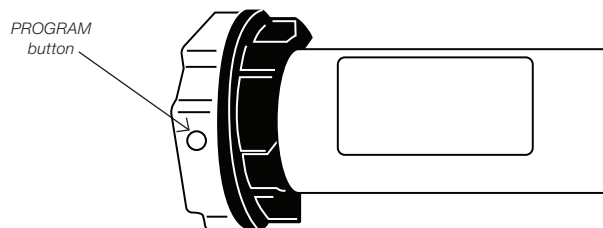

## PROGRAMMING AND OPERATION OF RADIO TECHNOLOGY MOTORS

**IMPORTANT:** The Upper & Lower limit positions (full UP & DOWN positions) have been pre-set at the factory – also, a Channel Number has been assigned to each shade - therefore, it is not necessary to perform Steps 1, 2 & 3 below – however, we recommend that you read these to familiarize yourself with the basics of programming the motor and remote control and to fully understand the function of your motorized shade. Also, note that the batteries in the motor are fully charged at the factory prior to shipment.

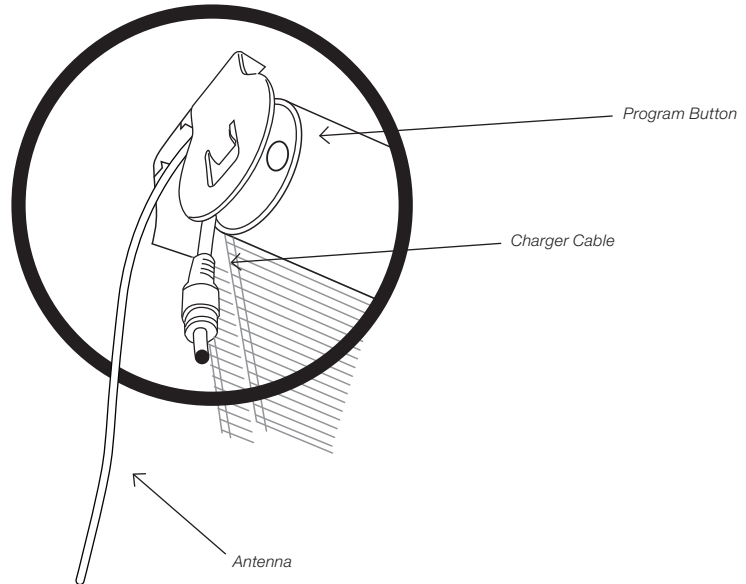

### 1. Channel Selection for Each Shade

When you receive your shades the channel number pre-assigned to each shade will be marked on the shade and/or carton. Per the notice above, it is not necessary to perform Steps 1, 2 & 3 as these settings are done at the factory and will require no adjustment under normal circumstances.

A channel number must be assigned to each motor/shade. The assigned numbers should be sequential starting with #1 (1, 2, 3 etc.).

Press the channel buttons/arrows to select a dedicated channel for each shade prior to mating each shade/motor to the remote controller.

### 2. Programming/Mating

REMINDER: the motor and remote have been pre-set at the factory – programming information for Steps 1, 2 & 3 is provided as background information only.

Identify the head of the motor housing on the left side of the shade (see drawing) - Press the PROGRAM button until the motor beeps and the shade oscillates (the shade will oscillate - a quick back and forth movement of the shade) Press the UP button on the remote (see drawing) – the shade will oscillate again – the motor and transmitter are now mated.

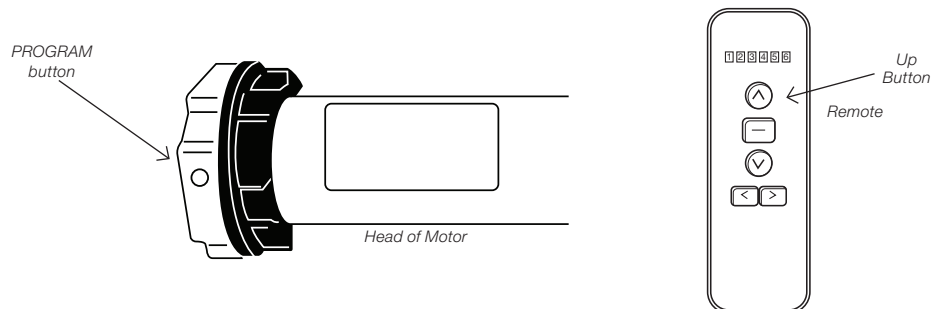

### 3. Setting UP and DOWN Limit Positions

NOTE: Upper and lower limit positions have been pre-set at the factory - programming information for Steps 1, 2 & 3 is provided as background information only.

**Set the UP position:**

Move the shade 6" to 10" below the desired upper limit by pressing the UP or DOWN arrows/buttons on the remote. Press the PROGRAM button on the back of the remote – the motor will oscillate – this puts the motor in program mode. Now move the shade up to the desired UP position and press the program button again – the motor will oscillate and the upper limit is now set.

### ***Set the DOWN position:***

Move the shade down from the upper limit position to a point 6" to 10" from the bottom, and then press the PROGRAM button on the back of the remote – the motor will oscillate and is once again in program mode. Now move the shade to the desired DOWN position and press the PROGRAM button the motor will oscillate and the lower limit is now set.

*NOTE: after all limits are set, see the remote control operating instructions below.*

## **4. Setting Intermediate Positions & Other Settings**

### ***Setting INTERMEDIATE positions***

Up to (4) intermediate positions can be set.

Move the shade at least 6 inches away from the previously set limits – press the PROGRAM button on the rear of the remote – the motor will oscillate and is now in program mode.

Now move the shade to any desired intermediate STOP position and press the PROGRAM button again – the motor will oscillate and the intermediate STOP position is now set.

Repeat this process to set additional intermediate STOP positions.

When setting a limit, if there is no action within 30 seconds, the motor will automatically exit the limit programming mode.

### ***Limit Position Fine Tuning:***

Move the shade to the limit position that you wish to adjust. Press the program button on the rear of the remote – the motor will oscillate and is now in limit setting mode. Use the UP/DOWN buttons on the remote to establish a new position – press the program button on the rear of the remote – the motor will oscillate and the fine-tune setting is now complete.

### ***Erasing Limits:***

*Note: the 1st/Upper limit cannot be erased – it can only be eliminated by deleting all memory*

Move the shade to the limit position that you wish to erase – press and hold the PROGRAM button on the rear of the remote for approximately 7 seconds – the motor will oscillate twice, and the limit has been erased.

### ***Deleting Memory***

***To Delete All Memory:*** Press the program button on the head of the motor 4 times (@ one second intervals), and then press a fifth time and hold the button down (approximately 7 seconds) until the motor oscillates twice. All memory is now erased.

***Deleting Memory for a Single Channel:*** Set the remote transmitter on the channel to be deleted. Press the STOP button for approximately 5 seconds – the motor will oscillate. Now press the program button on the rear of the remote – the motor will oscillate and the single channel is deleted

## **Using the Remote Control Transmitter**

Press the UP/DOWN button once and the shade will move to the next pre-set limit position.

Press the UP/DOWN button twice at the speed of once per second and the shade will move to the UP or DOWN limit position without stopping at any intermediate position.

When the up position has been reached, the UP button becomes non-functional, and when the down position has been reached the DOWN button becomes non-functional.

### **Controlling Multiple Shades Simultaneously**

6 Channel Remote: press the channel selector until all six lights are lit to control up to 6 shades at the same time using the remote control as described above.

16 Channel Remote: press the channel selector button until "CC" appears in the display window to control up to 16 shades at the same time using the remote control as described above.

## **Operating the Shade**

To raise and lower the shade, use the remote control as described above.

Use the UP & DOWN buttons on the remote to adjust the fabric panels to achieve any desired mix of light and privacy.

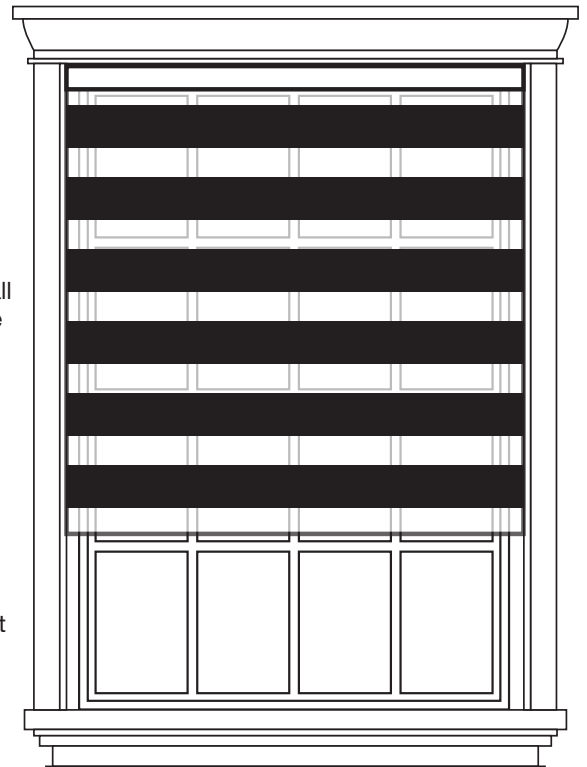

### Re-Charging the Batteries

The battery in each motor is fully charged when you receive your shade(s).

To re-charge, connect the AC Charger to the Charger Cable attached to the motor head – charge for 8 hours.

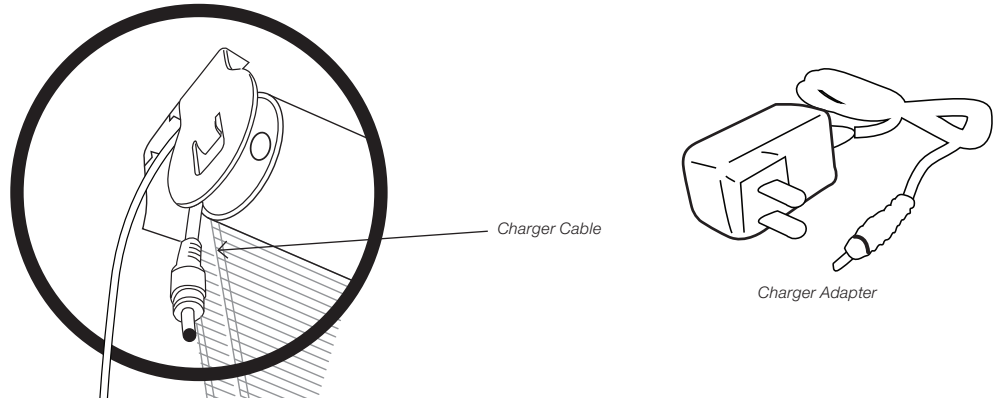

### Installation/Replacement of the Remote Control Battery

Remove the cover on the rear of the remote by removing the screw and sliding the back plate upward slightly – install a 3V [CR2032] disk type battery as illustrated.

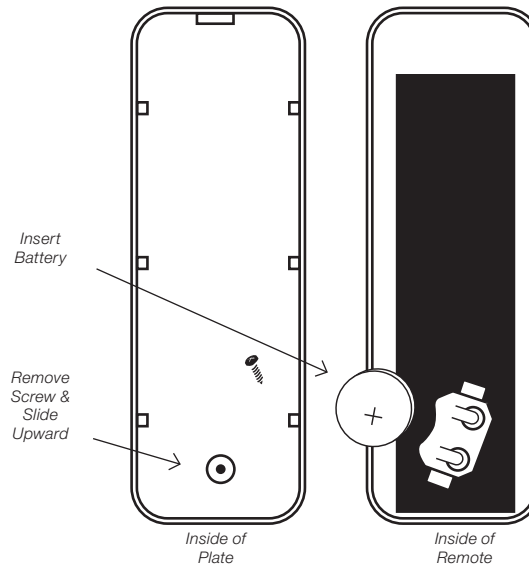

### Installation of Optional Wall Mount Holder

Attach the remote holder using the screws provided (use wall anchors for hollow dry wall), or peel the foil off the adhesive pad on the back of the remote holder and press it into place on any clean flat surface.

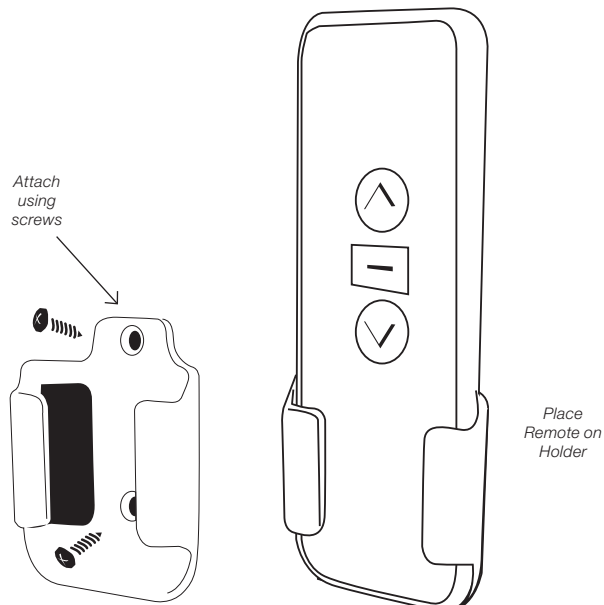

**CUSTOMER SERVICE: 1-800-264-1190**

### **General Safety Instructions for Motorized Shades**

- Do not expose the motor or transmitter to moisture or extreme temperatures
- Do not allow children to play with this device
- Use or modification outside the scope of this instruction manual will void the warranty
- If cable or power connector is damaged, do not use
- Keep the antenna straight and clear from metal objects

### **Statement Regarding FCC Compliance**

This device complies with Part 15 of the FCC rules. Operation is subject to the following two conditions:

- 1) This device may not cause interference, and
- 2) This device must accept any interference received, including interference that may cause undesired operation.

#### **Note:**

This equipment has been tested and found to comply with 15 of the FCC Rules. These limits are designed to provide reasonable protection against harmful interference in a residential installation. This equipment generates, uses and can radiate radio frequency energy and, if not installed and used in accordance with the instructions, may cause harmful interference to radio communications.

However, there is no guarantee that interference will not occur in a particular installation. If this equipment does cause harmful interference to radio or television reception, which can be determined by turning the equipment off and on, the user is encouraged to try to correct the interference by one or more of the following measures:

- Reorient or relocate the receiving antenna.
- Increase the separation between the equipment and the receiver.
- Connect the equipment into an outlet on a circuit different from that to which the receiver is connected.
- Consult the dealer or an experienced radio/TV technician for help.

Any changes or modifications not expressly approved by the party responsible for compliance could void the users authority to operate the equipment.

### **Cleaning**

To clean the shade fabric, use a feather duster or vacuum lightly using the soft brush or upholstery attachment. For spot cleaning, use warm (not hot!) water with a mild soap to damp clean.

### **REPLACEMENT PARTS**

In the event that replacement parts are ever needed, you may call: 1-800-264-1190

Please be sure to provide the following information, if possible:

- The complete model or catalog number of your product
- A description of the product
- A description of the part needed

### **LIMITED LIFETIME WARRANTY**

The enclosed product is warranted to the original residential retail purchaser as long as the product remains in the original window.

#### **Covered**

**Lifetime:** Entire product against manufacturing defects (i.e. a flaw in the product design, materials, or workmanship that causes the product to no longer function.

**3 Years:** Cords, including internal cords such as those found in cordless blinds or shades.

**5 Years:** All fabric

**3 Years:** Battery Operated Motors

#### **Not Covered**

1. Normal wear and Tear

2. Any product that fails due to:

- Abuse
- Alterations
- Exposure to salt air
- Improper cleaning
- Improper installation
- Misapplication
- Accident
- Damage from pests/insects/pets
- Extraordinary use
- Improper handling

- Improper operation
- Misuse

**3. Natural Wood Products that have:**

- Loss of color intensity
- Variations in color, grain or texture
- Warping of wood slats in high humidity areas

**4. Costs associated with:**

- Product removal
- Transportation to and from the retailer
- Brand label removal
- Product re-measure
- Product reinstallation
- Shipping
- Incidental or consequential damages

In the event there are multiple blinds/shades in the same room, only the defective blind/shade will be replaced

**To Report Shipping Damage:**

If damage occurred during shipping, call the place of purchase and report within 7 calendar days, or you may be denied credit for your damaged product.

**To Obtain Service:**

If you suspect this product has a manufacturing defect in materials or workmanship:

- Locate the sales receipt
- Call place of purchase

Any unauthorized returns will not be accepted.

**Warranty Remedy:**

This shall be your sole remedy under this limited warranty.

If this product is found to have a manufacturing defect in materials or workmanship, we will, at our discretion, do one of the following:

- Repair the product
- Replace the product
- Refund the cost of the product

Colors may vary from lot to lot and may not exactly match sample swatches or previous purchases.

Discontinued items or color selections will be replaced with the closest equivalent current product.

Your rights under state law: This lifetime limited warranty gives you specific legal rights, and you may have other rights which vary from state to state. Some states do not allow limitations on how long a warranty lasts, so the above limitations may not apply to you. No agent, representative, dealer

or unauthorized employee has the authority to increase or alter the obligation of this warranty. This lifetime limited warranty supersedes any previous versions